

american national standard

*for Industrial Robots and Robot Systems —
Safety Requirements*



ROBOTIC INDUSTRIES ASSOCIATION
P.O. BOX 3724
ANN ARBOR MI 4 8106

ANSI/RIA R15.06-1999

Revision of
ANSI/RIA R15.06-1992

American National Standard
for Industrial Robots and Robot Systems —

Safety Requirements

Secretariat
Robotic Industries Association

Approved June 21, 1999
American National Standards Institute, Inc.

American National Standard

Approval of an American National Standard requires verification by ANSI that the requirements for due process, consensus, and other criteria for approval have been met by the standards developer.

Consensus is established when, in the judgment of the ANSI Board of Standards Review, substantial agreement has been reached by directly and materially affected interests. Substantial agreement means much more than a simple majority, but not necessarily unanimity. Consensus requires that all views and objections be considered, and that a concerted effort be made toward their resolution.

The use of American National Standards is completely voluntary; their existence does not in any respect preclude anyone, whether he has approved the standards or not, from manufacturing, marketing, purchasing, or using products, processes, or procedures not conforming to the standards.

The American National Standards Institute does not develop standards and will in no circumstances give an interpretation of any American National Standard. Moreover, no person shall have the right or authority to issue an interpretation of an American National Standard in the name of the American National Standards Institute. Requests for interpretations should be addressed to the secretariat or sponsor whose name appears on the title page of this standard.

CAUTION NOTICE: This American National Standard may be revised or withdrawn at any time. The procedures of the American National Standards Institute require that action be taken periodically to reaffirm, revise, or withdraw this standard. Purchasers of American National Standards may receive current information on all standards by calling or writing the American National Standards Institute.

Published by

**Robotic Industries Association
P. O. Box 3724, Ann Arbor, MI 48106**

© 1999 Robotic Industries Association
All rights reserved

No part of this publication may be reproduced in any form, in an electronic retrieval system or otherwise, without prior written permission of the publisher.

Printed in the United States of America

6P E ED

Contents	Page
Foreword.....	vii
0 Introduction.....	1
1 Scope, purpose, application and exclusions	2
1.1 Scope	2
1.2 Purpose.....	2
1.3 Application.....	2
1.3.1 New or remanufactured robots.....	2
1.3.2 Rebuilt or re-deployed robots.....	2
1.3.3 New robot systems and work cells.....	2
1.3.4 Existing robot systems and work cells	2
1.4 Exclusions	3
2 Normative references	3
3 Definitions	3
4 Manufacture, remanufacture, and rebuild of robots	6
4.1 Requirements.....	6
4.1.1 New and remanufactured robots.....	6
4.1.2 Rebuilt robots	6
4.2 Hazards to personnel	6
4.2.1 Power transmission components	6
4.2.2 Failure to reach intended location	6
4.2.3 Power loss or change.....	7
4.2.4 Component malfunction	7
4.2.5 Sources of energy	7
4.2.6 Stored energy.....	7
4.2.7 Electromagnetic interference, radio frequency interference and electrostatic discharge.....	7
4.3 Movement without drive power	7
4.4 Actuating controls.....	7
4.4.1 Protection from unintended operation.....	7
4.4.2 Status indication.....	7
4.4.3 Labeling.....	8
4.4.4 Remotely located controls.....	8
4.5 Safety circuit performance.....	8

4.5.1	Simple.....	8
4.5.2	Single channel.....	8
4.5.3	Single channel with monitoring.....	8
4.5.4	Control reliable	8
4.6	Robot stopping circuits	9
4.6.1	Emergency stop.....	9
4.6.2	Emergency stop devices	9
4.6.3	Emergency stop device design.....	9
4.6.4	Stopping with power off	9
4.6.5	Safety stop.....	9
4.7	Pendant and other teaching controls.....	10
4.7.1	Automatic.....	10
4.7.2	Motion control	10
4.7.3	Enabling device	10
4.7.4	Pendant emergency stop.....	10
4.7.5	Single point of control	10
4.8	High speed APV requirements	10
4.9	Slow speed control	11
4.10	Singularity protection.....	11
4.11	Axis limiting devices	11
4.12	Provisions for lifting	11
4.13	Electrical connectors	11
4.14	Hoses.....	12
4.15	Failures	12
4.16	Required information	12
5	Performance requirements of safeguarding devices	13
5.1	Barrier guards, fixed and interlocked.....	13
5.2	Interlocking safeguarding devices	13
5.2.1	Mechanical devices	13
5.2.2	Electrical devices.....	14
5.3	Requirements for other safeguarding devices that signal a stop.	14
5.3.1	Safety light curtains/screens	14
5.3.2	Area scanning safeguarding devices	15
5.3.3	Radio frequency (RF)/capacitance safeguarding devices	15
5.3.4	Safety mat systems	16
5.3.5	Single and multiple beam safety systems.....	16

5.3.6	Two hand control systems	16
6	Installation of robots and robot systems	17
6.1	Installation specification	17
6.2	Environmental conditions	17
6.3	Control location	17
6.3.1	Actuating controls	17
6.4	Safety related software and firmware based controllers	17
6.5	Limiting devices	18
6.6	Restricted space identification	18
6.7	Dynamic restricted space	18
6.8	Robot system clearance	18
6.9	Power requirements	18
6.10	Grounding requirement	18
6.11	Power disconnect	18
6.12	Robot system stopping circuits	18
6.12.1	Robot system emergency stop	19
6.12.2	Robot system emergency stop device location	19
6.12.3	Robot system emergency stop device design	19
6.12.4	Robot workcell emergency stop function	19
6.12.5	Safety stops	19
6.13	Associated equipment shutdown	20
6.14	End-effector power loss or change	20
6.15	Emergency recovery procedure	20
6.16	Precautionary labels	20
6.17	Required information	20
7	Safeguarding of personnel - Introduction	20
7.1	Responsibility	20
7.2	Implementation	20
7.3	Robot or robot system implementation stages	20
7.4	Sources of hazards	21
7.5	Safeguarding methodology selection	21
8	Safeguarding of personnel - Prescribed method	22
8.1	Safeguarding requirements	22
8.2	Restricted space	22
8.3	Protection of personnel outside the safeguarded space	22

8.4	Protection of personnel within the safeguarded space.....	22
8.5	Point of operation hazards	22
9	Safeguarding of personnel - Risk assessment method.....	23
9.1	Requirements	23
9.2	Task and hazard identification.....	23
9.3	Risk estimation.....	23
9.4	Risk reduction determination.....	24
9.5	Safeguard selection.....	25
9.5.1	Category R1 risk reduction	25
9.5.2	Category R2 risk reduction	25
9.5.3	Category R3 risk reduction	25
9.5.4	Category R4 risk reduction	25
9.6	Selection validation.....	26
9.7	Documentation	26
10	Safeguarding of personnel - Implementation.....	26
10.1	Requirements of safety circuit performance	26
10.2	Limiting robot motion	27
10.2.1	Mechanical limiting devices	27
10.2.2	Non-mechanical limiting devices	27
10.2.3	Dynamic limiting devices	27
10.3	Pendants	27
10.3.1	New installations	27
10.3.2	Existing installations.....	27
10.4	Safeguarding devices - application, integration and installation requirements.....	27
10.4.1	Purpose of safeguarding devices	27
10.4.2	Safeguarding device selection	28
10.4.3	Safeguarding device safety distance	29
10.4.4	Bypassing safeguarding devices	29
10.4.5	Muting	30
10.4.6	Safeguarding device electrical integration	30
10.4.7	Start and Restart.....	31
10.5	Awareness means.....	31
10.5.1	Awareness barrier	31
10.5.2	Awareness signal	31
10.6	Procedures and training	31

10.7	Safeguarding the teacher	31
10.7.1	Training	31
10.7.2	Preparation	32
10.7.3	Functional safeguards	32
10.7.4	Protection from adjacent hazards.....	32
10.7.5	Selecting teach mode	32
10.7.6	Automatic mode	32
10.7.7	Clearance	33
10.8	Safeguarding personnel during program verification	33
10.8.1	Verification from outside the safeguarded space	33
10.8.2	Slow speed attended program verification	33
10.8.3	High-speed attended program verification	33
10.8.4	Requirements for high speed APV.....	33
10.8.5	Clearance for high speed APV	34
10.9	Safeguarding the operator.....	34
10.9.1	Requirements.....	35
10.9.2	Presence sensing device initiation (PSDI)	35
10.10	Safeguarding maintenance personnel	36
10.10.1	Access to safeguarded space with no drive power available	36
10.10.2	Access to safeguarded space with drive power available.....	36
10.10.3	Entry procedures	36
10.10.4	Control of robot and robot system	36
10.10.5	Additional safeguarding methods	37
10.10.6	Alternate safeguards	37
10.11	Safeguarding verification.....	37
11	Safeguarding devices - application requirements	37
11.1	Barrier guards, fixed and interlocked	37
11.2	Barrier guards, interlocked	38
11.2.1	Barrier portion.....	38
11.2.2	Interlocking portion.....	38
11.3	Requirements for other safeguarding devices that signal a stop.....	39
11.4	Safety light curtains/screens.....	39
11.5	Area scanning safeguarding devices.....	40
11.6	Radio frequency (RF)/capacitance safeguarding devices	40
11.7	Safety mat systems.....	41
11.8	Single and multiple beam safety systems.....	41

11.9 Two hand control systems.....	41
12 Maintenance of robots and robot systems.....	42
13 Testing and start-up of robots and robot systems	42
13.1 Interim safeguarding	42
13.1.1 Selection of interim safeguards.....	43
13.2 Manufacturer/integrators' instructions	43
13.3 Initial start-up procedure	43
13.4 Personnel protection	44
14 Safety training of personnel	44
14.1 Training objectives.....	44
14.2 Training requirements	44
14.2.1 Safeguard training.....	44
14.2.2 Training the teacher	45
14.2.3 Training the operator	45
14.2.4 Training the APV operator	45
14.2.5 Training maintenance personnel	46
14.3 Retraining requirements	46

Tables

1 Hazard severity/exposure/avoidance categories	24
2 Risk reduction decision matrix prior to safeguard selection	24
3 Safeguard selection matrix	25
4 Safeguard selection validation matrix with safeguards installed.....	26
5 Minimum distance from hazard as a function of barrier opening size	28
6 Minimum distance from hazard for a device which signals a stop	29

Figures

1 Logic flow of document.....	1
-------------------------------	---

Annex

A Graphical aids to understanding the standard	47
B Safeguarding device supplemental information	53
C Risk Assessment	62
D Training.....	68
E Bibliography.....	74

Foreword (Not part of American National Standard ANSI/RIA R15.06-1999)

The objective of this standard is to enhance the safety of personnel using industrial robot systems by establishing requirements for the manufacture (including remanufacture and overhaul,) installation, safeguarding methods, maintenance and repair of manipulating industrial robots.

To accomplish this objective, the Robotic Industries Association Subcommittee R15.06 on Safety considered the variety of tasks necessary for the efficient and productive use of Industrial Robots. The operational scope and characteristics of a robot may be significantly different than other equipment and machines, and certain tasks may require persons to be in the proximity of the robot while drive power is available. An industrial robot may not be a stand-alone machine, but rather may interact with other machines and equipment.

To assist in the interpretation of this standard, the Subcommittee intended that the manufacturer (including remanufacturer and rebuilder,) the installer, and the end user have specific responsibilities. From a practical standpoint, the ultimate responsibility for safeguarding of persons associated with industrial robots and industrial robot systems lies with the person(s) themselves. Safety cannot be regulated by a book; it must be a conscious effort on the part of all parties (manufacturer, integrator, and user.) Necessary components in every safeguarding system are the maintenance of and adherence to the system design. Personnel skills, training, and attitude are important factors in a safety program. This standard only serves to provide guidelines to a safe operation.

Terms which are defined in clause 3 appear in **bold** type when used in other definitions, and the first time they are used in context within each clause. The words "shall" and "will" are intended to be prescriptive, and required to be in compliance with this standard. The words "should" and "may" are meant to be recommendations and good practices. Notes used throughout the document are generally meant to provide explanatory information, but may be normative when the word convention above is used.

This standard is a revision of ANSI/RIA R15.06-1992. Changes were incorporated based on public comments received, and an extensive review by the R15.06 Subcommittee. Some of the most significant changes include:

- Requirement to retrofit some existing installations with enabling devices and other safeguarding requirements not meeting a minimum criteria (1.3)
- A major reorganization of the text, creating clauses for the addition of responsibilities for the manufacturer of safety devices (clause 5), separate and enhanced clauses for safeguarding of personnel (clause 7 - Introduction; clause 8 - Prescribed method; clause 9 - Risk assessment method; and clause 10 - Procedures), and safeguard device installation requirements (clause 11), and renumbering of paragraphs
- Deletion of attended continuous operation, and revised requirements for Attended Program Verification (10.8)
- Requirement for separate stopping circuits, emergency stop and safety stop (4.6 and 6.12)

- Additional requirements regarding pendants and enabling devices (4.7); control circuitry (4.5 and 10.1); awareness signals for failure to reach intended location (4.2.2) and singularity (4.10); and mechanical axis stops (4.11 and 6.5)
- Specific clearance requirements for teach (10.7.7) and APV (10.8.5)
- Additional charts, tables, and informative annexes
- Use of the term “space” in place of “envelope” to describe three dimensional robot operating requirements

Industry standards, including this one, are voluntary. The Robotic Industries Association makes no determination with respect to whether any robot, associated safety devices, manufacturer, or user is in compliance with this standard.

This standard contains five (5) annexes, all of which are informative.

Suggestions for improvement of the standard are welcome. They should be sent to the:

RIA Subcommittee on Safety
P. O. Box 3724
Ann Arbor, MI 48106

Consensus for approval of this standard as an American National Standard was achieved by balloting of the R15 Standards Approval Committee of the Robotic Industries Association (an accredited standards developing organization). Committee approval of this standard does not necessarily imply that all committee members voted for its approval. At the time it approved this standard, the R15 Standards Approval Committee had the following members:

William Drotning, Chairman

<i>Organization Represented</i>	<i>Name of Representative</i>
ABB Flexible Automation	Michael Calardo
Adept Technology	Glyn Garside
Association for Manufacturing Technology	Charles Carlsson
Caterpillar	Ken Bixby
Corning Incorporated	Roosevelt Dillard
Deneb Robotics	Brian Huse
Ford Motor Company	Tomas Pearson
General Electric Aircraft Engines	Keith Betscher
General Motors NAO Robotics	Leroy Rodgers
Genesis Systems	Charles Keibler
GM Delphi Saginaw Steering Systems	Larry Morel
IBM Corporation	Jerry Quint
International Union of Automobile Workers (UAW)	James Howe
John Deere Worldwide	Thomas Tabaska
Lehigh University	Duke Perreira
Liberty Mutual Group	John Russell
Mitsubishi Motor Manufacturing of America	Eugene Schlueter
Motoman	Izzat Hammad
National Electrical Manufacturers Association	Larry Miller
National Institute of Standards and Technology	Nicholas Dagalakis
Panasonic Factory Automation	Martin Weir
PaR Systems	Todd Holt
R15.03 Subcommittee for Mechanical Interface	Hadi Akeel
R15.05 Subcommittee for Performance	James Wells
	Steve Walsh (Alt.)

<i>Organization Represented</i>	<i>Name of Representative</i>
R15.06 Subcommittee for Safety	Roberta Nelson
R15.07 Subcommittee for Simulation and Off-line Pgm	Craig Battles
	Carl Traynor (Alt.)
Robodyne Corporation	Joseph Alvité
Sandia National Laboratories	William Drotning
SICK Optic-Electronic	Richard Mills
Society of the Plastics Industry	Walter Bishop
Tower Automotive	Richard Lefebvre
Underwriters Laboratories	Marvin Winrich
University of Southern California	Mansour Rahimi

Subcommittee R15.06 on Industrial Robot Safety, which developed this standard had the following members:

Roberta Nelson, Chair

Hadi A. Akeel	William Drotning	Thomas Pilz
Brad R. Barber	Robert Frease	Eugene Schlueter
John Beard	Steven Freedman	Joe Schultz
Tom Bertellotti	Glyn Garside	Malcolm Sharp
Keith H. Betscher	Izzat Hammad	Randy J. Smitt
Michael J. Bomya	Andrew G. Hamor	John E. Steinmann
John D. Brazil	Marty Hilbrands	Dave Sytkowski
Ray Butler	Jim Howe	Thomas E. Tabaska
Ray Carby	Thomas Huff	Kenneth T. Thompson
Mike Carlson	Richard Kochis	Brian Wallace
Nicholas G. Dagalakis	Vernon L. Mangold, Jr.	Martin M. Weir
Robert Dean	Richard L. Mills	Curtis Weispfenning
Tim Denaro	Thomas D. Moran	Ted Whittlinger
Roosevelt Dillard	Jim Morber	Marvin Winrich
Gil Dominguez	Jim Mumaw	Patricia A. Yoblin

Corresponding, alternate and liaison members included:

Gerald Albaugh	Jim Harbin	Joe Pomata
Joe Alvité	Jeff Hardesty	Jerry Poppe
Chris Anderson	Christopher Hellmann	R. Todd Priest
Peter Barroso	Douglas H. Hinesley	Jerry Quint
Richard Baumann	Robert L. Hooper	Fred Robinson
Joseph P. Bellino	Edward Karl	Carel Russell
Alex Bilsland	Jeff Kauzlarich	Jeff Ruxer
Walter Bishop	Tom Keener	Kimiharu Sato
Ken Bixby	Craig Kochsiek	Roland Schibli
Anthony Bodetti	Chris Koknat	Homer Selby
Richard Breen	Eric M. Kot	Ron Shade
Rick Brookshire	Gary Kucharski	John Smith
Mike Brosius	Mike Kunkle	Ken Solomon
Kirk Bunner	Jack D. Lane	Kevin Sorensen
Joseph S. Byrd	Martin Lawson	Randy Soto
Mike Calardo	Curt Layman	Brian Sukarukoff
Charles Carlsson	Ion Manea	Paul Taber
Kevin Clark	James M. Martin	Tommy Thomas
Steven Coate	John McCurdy	Alan Traylor
Len Connor	Jerry E. McKenzie	David Trees
Don Cowles	Zane Michael	Mark Ulrich
Howard DeWees	H. Don Moore	Richard VanDeBogart
Brian Friedrichs	Doris Morgan	Thomas H. Via
Peter Früauf	Robert Noch	Paul Walker
Anatoly Galperin	Joseph-Jean Paques	Tim Watt
Bob Ganfield	James D. Piccard	Randy Wiest
Dennis Grabowski	Tom Polistina	
Les Graham	Geoff Polzin	

Administrative services provided by J. D. (Jeff) Fryman, Jr. of the Robotic Industries Association

Illustrations courtesy of Ray Butler. Illustration B.2 by Roberta Nelson Shea, and B.3 by Malcolm Sharp

American National Standard
for Industrial Robots and Robot Systems –

Safety Requirements

0 Introduction

This standard assigns responsibilities for **industrial robot** safety to manufacturers, integrators, installers, and the **user**. Proper **safeguarding** of personnel is determined as prescribed in clause 8 or clause 9. The standard is best read in its entirety for full comprehension of requirements. Figure 1 gives a graphic presentation of the flow of responsibilities through the document.

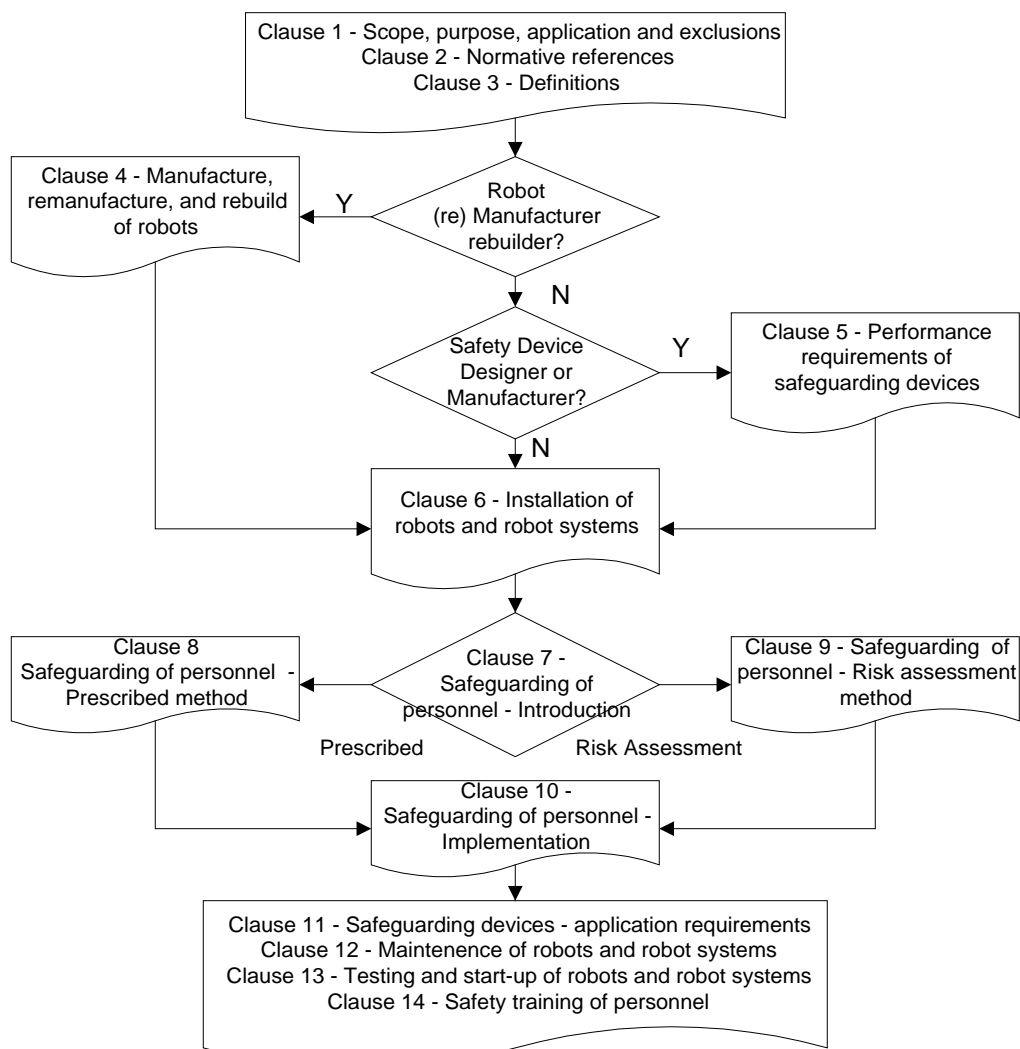

Figure 1 – Logic flow of document

1 Scope, purpose, application and exclusions

1.1 Scope

This safety standard applies to the manufacture, remanufacture, rebuild, installation, **safeguarding**, maintenance, testing and start-up, and training requirements for **industrial robots** and **robot systems**.

1.2 Purpose

The purpose of this standard is to provide requirements for industrial robot manufacture, remanufacture and rebuild; robot system integration/installation; and methods of safeguarding to enhance the safety of personnel associated with the use of robots and robot systems.

NOTE – As used in this standard, the words “robot” or “robot system” are intended to mean “industrial robots” or “industrial robot systems” as defined in clause 3.

1.3 Application

The requirements of this standard shall be applied per 1.3.1 through 1.3.4. This in no way reduces the responsibility of the manufacturer, integrator, or **user** to be in compliance with the previous standard (ANSI/RIA R15.06-1992) prior to the effective dates, or with other applicable industry standards, for all new and existing systems. The effective dates are established by the standards-developing organization and not by the American National Standards Institute.

NOTE – See table A.1 for effective dates by application.

1.3.1 New or remanufactured robots

The requirements of this standard shall apply to all newly manufactured robots and all remanufactured (upgraded) robots within twenty-four (24) months after the approval date of this standard. Manufacture includes the design, engineering, construction, functional test and distribution of an industrial robot. Remanufacture includes any engineering or construction of existing robots to new or revised specification (of the original manufacturer or other source). This includes upgrade and modification work on the robot exclusive of software updates.

1.3.2 Rebuilt or re-deployed robots

Robots which are rebuilt or re-deployed shall comply with the standard in effect on the date of original manufacture. This does not preclude the addition of safety enhancements of this standard. Rebuilt robots are those which are overhauled and repaired to their original condition and manufacturer’s original or current specifications for that model robot including software changes. This includes overhaul and repair, reconditioning, refurbishment, or restoration. Re-deployed robots are those which are physically moved and only with changes to the **task program** and **end-effector**.

1.3.3 New robot systems and work cells

The requirements of this standard shall apply to all new robot systems or work cells within thirty-six (36) months after the approval date of this standard.

1.3.4 Existing robot systems and work cells

Existing robot systems or work cells which were installed prior to the effective date of this standard do not require retrofit (except as required in 10.3.2 **Pendants** and 10.8.4b-p Requirements for high speed APV) if they comply with the standard(s) in effect on the date of installation and are installed such that they:

- a) are guarded such that intrusion into the **restricted space** will interrupt the automatic **cycle** of the robot task program, and
- b) have **emergency stop** circuitry in full compliance with NFPA 79 on date of installation.

Any system or work cell not meeting these requirements shall be retrofit within twenty-four (24) months of approval of this standard.

NOTE – Circuitry for any retrofit should comply with 4.5.2 at a minimum.

1.4 Exclusions

This Standard applies to industrial robots and robot systems only. Examples of non-industrial robot applications include, but are not limited to: undersea and space robots, tele-operated manipulators, prosthetics and other aids for the handicapped, micro-robots (displacement <1 mm), autonomous mobile robots, surgery and service.

2 Normative references

The following standards contain provisions which, through reference in this text, constitute provisions of this American National Standard. At the time of publication, the editions indicated were valid. All standards are subject to revision, and parties to agreements based on this American National Standard are encouraged to investigate the possibility of applying the most recent editions of the standards indicated below.

ANSI/NFPA 79-1997 - *Electrical standard for industrial equipment*

ANSI/UL 1740-1998 - *Safety standard for robots and robotic equipment*

OSHA 1904 - *General requirement for recording and reporting occupational injuries and illnesses¹*

OSHA 1910.147 - *Control of hazardous energy (Lockout/Tagout)*

OSHA 1910.212 - *General requirements for all machines (Machine guarding)*

OSHA 1910.219 - *Mechanical power transmission apparatus*

3 Definitions

The definitions below are particular to this standard. Any other terms are explained as they are used in the document, or would be found in a dictionary.

3.1 actuator: A mechanism used to effect motion.

- a) A power mechanism which converts electrical, hydraulic or pneumatic energy to effect motion.
- b) A mechanical mechanism within a control device (e.g. a rod which opens contacts.)
- c) A device (e.g. specialized key) which initiates a (un)locking sequence.

3.2 attended program verification: The act when a person within the **safeguarded space** verifies the **robot's programmed** tasks at programmed speed. This is not **teach mode**, see 3.44.

3.3 automatic mode: Operating mode in which the control system operates in accordance with the **task program**.

¹ OSHA regulatory standards available from the Superintendent of Documents, GPO, Washington, DC 20401

- 3.4 automatic operation:** The state in which the **robot** is executing its **programmed** task as intended.
- 3.5 awareness barrier:** Physical and visual means that warn a person of an approaching or present **hazard**.
- 3.6 awareness signal:** A device that warns a person of an approaching or present **hazard** by an audible or visible means.
- 3.7 barrier:** A physical means of separating persons from the **hazard**.
- 3.8 coordinated motion:** Control wherein the axes of the robot arrive at their respective end points simultaneously, giving a smooth appearance to the motion. Control wherein the motions of the axes are such that the **tool center point** (TCP) moves along a prescribed path (line, circle, or other).
- 3.9 cycle:** The single execution of a **task program**.
- 3.10 drive power:** The **energy source** or sources for the **robot actuators**.
- 3.11 emergency stop:** The operation of a circuit that overrides all other **robot** controls, removes **drive power**, causes all moving parts to stop, and removes power from other hazardous functions present in the **safeguarded space** but does not cause additional **hazards**.
- 3.12 enabling device:** A manually operated device which when continuously activated, permits motion.
- 3.13 end-effector:** An accessory device or tool specifically designed for attachment to the **robot** wrist or tool mounting plate to enable the robot to perform its intended task. (Examples may include gripper, spot weld gun, arc weld gun, spray paint gun, or any other application tools.)
- 3.14 energy source:** Any electrical, mechanical, hydraulic, pneumatic, chemical, thermal, potential, kinetic or other sources of power/movement.
- 3.15 envelope:** The three dimensional volume of **space** encompassing the movements of all **robot** parts (see **space**).
- 3.16 hazard:** A potential source of harm.
- 3.17 hazardous motion:** Any motion that is likely to cause personal physical harm.
- 3.18 industrial robot:** An automatically controlled, reprogrammable multipurpose manipulator **programmable** in three or more axes which may be either fixed in place or mobile for use in industrial automation applications.
- 3.19 industrial robot system:** Equipment that includes the robot(s) (hardware and software) consisting of the manipulator power supply and control system; the **end-effector(s)**; and any other associated machinery and equipment within the **safeguarded space**.
- 3.20 interlock:** An arrangement whereby the operation of one control or mechanism allows, or prevents the operation of another.
- 3.21 limiting device:** A device that restricts the **maximum space** by stopping or causing to stop all **robot** motion and is independent of the **control program** and the **task programs**.
- 3.22 operator:** The person designated to start, monitor and stop the intended operation of a **robot** or **robot system**. An operator may also interface with a robot for production purposes.
- 3.23 pendant:** A hand-held device linked to the control system with which a **robot** can be **programmed** or moved. Also called **teach pendant**.
- 3.24 point of operation:** The location(s) within the **safeguarded space** where work is performed on the material or workpiece.

3.25 presence-sensing safeguarding device: A device designed, constructed and installed to create a sensing field or area to detect intrusion or presence within such field or area by personnel, **robots**, or other objects.

3.26 program: (see below)

3.26.1 control program: The inherent set of control instructions which defines the capabilities, actions and responses of the **robot system**. This **program** is usually not intended to be modified by the **user**.

3.26.2 task program: Set of instructions for motion and auxiliary functions that define the specific intended task of the **robot system**.

3.26.3 task programming: The act of providing the **task program** (see 3.43 **teach**).

3.27 program path: The path traced by the **TCP** during the execution of a **task program**.

3.28 program verification: The execution of path instructions for the purpose of confirming the **robot** path and process performance. Verification may include the total **program path** or a segment of the path. The instructions may be executed in a single instruction or continuous instruction sequence. It is used in new applications and in fine tuning/editing of existing ones.

3.29 residual risk: That **risk** that remains after **safeguarding devices** have been applied.

3.30 risk: A combination of the probability and the degree of the possible injury or damage to health in a hazardous situation.

3.31 risk assessment: A comprehensive evaluation of the possible injury or damage to health in a hazardous situation in order to select appropriate **safeguards**.

3.32 robot: See 3.18 **industrial robot**.

3.33 robot system: See 3.19 **industrial robot system**.

3.34 safeguard: A **barrier** guard, device or safety procedure designed for the protection of personnel.

3.35 safeguarding: The act of providing personnel with protection from a **hazard**.

3.36 safeguarding device: A means that detects or prevents access to a **hazard**.

3.37 safety rated: Tested, evaluated, and proven to operate in a reliable and acceptable manner when applied in a function critical to health and welfare of personnel.

3.38 safety stop: A type of interruption of operation that allows an orderly cessation of motion for **safeguarding** purposes. This stop retains the **program** logic for trouble shooting purposes and to facilitate a restart.

3.39 single point of control: The ability to operate the **robot** such that initiation of robot motion from one source of control is only possible from that source and cannot be overridden from another source.

3.40 singularity: A condition caused by the collinear alignment of two or more **robot** axes resulting in unpredictable robot motion and velocities.

3.41 slow speed control: A mode of **robot** motion control where the speed is limited to ≤ 250 mm/sec (10 in/sec) to allow persons sufficient time to either withdraw from **hazardous motion** or stop the robot.

3.42 space: The three dimensional volume encompassing the movements of all **robot** parts through their axes (previously called **envelope**, see annex A for illustrations).

3.42.1 maximum space: The volume of **space** encompassing the maximum designed movements of all **robot** parts including the **end-effector**, workpiece and attachments.

3.42.2 restricted space: That portion of the **maximum space** to which a **robot** is restricted by **limiting devices**. The maximum distance that the robot, **end-effector**, and work piece can travel after the limiting device is actuated defines the boundaries of the restricted space of the robot.

3.42.3 operating space: That portion of the **restricted space** that is actually used by the **robot** while performing its **task program**.

3.42.4 safeguarded space: The **space** defined by the perimeter **safeguarding devices**.

3.43 teach (programming): Programming performed by:

- a) manually leading the **robot end-effector**; or
- b) manually leading a mechanical simulating device; or
- c) using a teach **pendant** to move the **robot** through the desired actions.

3.44 teach mode: The control state that allows the generation, storage and playback of positional data points while under **slow speed control**. This is not verification, see 3.2.

3.45 teacher: A person who provides the **robot** with a specific set of instructions to perform a task.

3.46 tool center point (TCP): The point defined for a given application with regard to the mechanical interface coordinate system.

3.47 user: An entity which uses **robots**, and is responsible for the personnel associated with the robot operation.

4 Manufacture, remanufacture, and rebuild of robots

4.1 Requirements

4.1.1 New and remanufactured robots

Anyone manufacturing, or remanufacturing, a **robot** shall meet all requirements contained in 4.2 - 4.16 of this standard.

4.1.2 Rebuilt robots

Anyone rebuilding a robot shall do so in accordance with 1.3.2.

4.2 Hazards to personnel

Potential **hazards** to personnel shall be eliminated by design, or protection shall be provided against the hazards. If a hazard cannot be eliminated by either design or protection, a warning against the specific hazard shall be provided. (OSHA 1910.212)

4.2.1 Power transmission components

Robots shall be designed and constructed to prevent exposure to components such as motors, gears, drive belts or linkages. (OSHA 1910.219)

4.2.2 Failure to reach intended location

If failure of the robot to reach an intended location presents a hazard, a stop shall be initiated and an **awareness signal** generated.

4.2.3 Power loss or change

Robots shall be designed and constructed so that loss of electrical power or voltage surges or changes in oil or air pressure will not result in a hazard.

4.2.4 Component malfunction

Robot components shall be designed, constructed, secured or contained so hazards caused by breaking or loosening, or releasing stored energy are minimized.

4.2.5 Sources of energy

A means of isolating any electrical, mechanical, hydraulic, pneumatic, chemical, thermal, potential, kinetic or other hazardous **energy source** to the robot shall be provided. This means shall be provided with lockout/tagout capability in accordance with Federal OSHA 1910.147 or local OSHA equivalent.

4.2.6 Stored energy

Means shall be provided for the controlled release of stored energy. This energy may be in the form of, but not limited to, air and hydraulic pressure accumulators, capacitors, springs, counter balances and flywheels. When appropriate, a label shall be affixed to the stored energy source to identify the hazard.

4.2.7 Electromagnetic interference, radio frequency interference and electrostatic discharge

The design and construction of the robot shall incorporate good engineering practices of shielding, filtering, suppression and grounding to prevent **hazardous motion** due to the effects of Electromagnetic Interference (EMI) and Radio Frequency Interference (RFI), and Electrostatic Discharge (ESD).

4.3 Movement without drive power

The robot shall be designed so that the axes are capable of being moved without using **drive power**.

NOTE – Emergency or abnormal conditions may require robot axes be moved without drive power. The manufacturer should provide a means which allows:

- a) single and/or combination axes motion
- b) operation by a single person (preferred)

The user needs to be made aware that gravity and the release of braking devices can create additional hazards. Personnel should be trained to respond to emergency situations (clause 14).

4.4 Actuating controls

4.4.1 Protection from unintended operation

Actuating controls that initiate power or motion shall be constructed or located so as to prevent inadvertent operation. For example, a guarded push-button, key selector switch or two-handed control may be used.

4.4.2 Status indication

Actuating controls shall include an indication of the operating status.

4.4.3 Labeling

Actuating controls shall be labeled to clearly indicate their function.

4.4.4 Remotely located controls

A robot that can be controlled from a remote location(s) shall have a local means that, when used, prevents the initiation of robot motion from any other location.

4.5 Safety circuit performance

Safety circuits (electric, hydraulic, pneumatic) shall meet one of the performance criteria listed in 4.5.1 through 4.5.4.²

4.5.1 Simple

Simple safety circuits shall be designed and constructed using accepted single channel circuitry, and may be programmable.

4.5.2 Single channel

Single channel safety circuits shall be hardware based or comply with 6.4, include components which should be **safety rated**, be used in compliance with manufacturers' recommendations and proven circuit designs (e.g. a single channel electro-mechanical positive break device which signals a stop in a de-energized state.)

4.5.3 Single channel with monitoring

Single channel with monitoring safety circuits shall include the requirements for single channel, shall be safety rated, and shall be checked (preferably automatically) at suitable intervals.

- a) The check of the safety function(s) shall be performed
 - 1) at machine start-up, and
 - 2) periodically during operation;
- b) The check shall either:
 - 1) allow operation if no faults have been detected, or
 - 2) generate a stop signal if a fault is detected. A warning shall be provided if a hazard remains after cessation of motion;
- c) The check itself shall not cause a hazardous situation;
- d) Following detection of a fault, a safe state shall be maintained until the fault is cleared.

4.5.4 Control reliable

Control reliable safety circuitry shall be designed, constructed and applied such that any single component failure shall not prevent the stopping action of the robot.

² These performance criteria are not to be confused with the European categories B to 3 as described in ISO/IEC DIS 13849-1, Safety of machinery – Safety-related parts of control systems – Part 1: General principles for design (in correlation with EN 954-1.) They are different. The committee believes that the criteria in 4.5.1-4.5.4 exceed the criteria of B - 3 respectively, and further believe the reverse is not true.

These circuits shall be hardware based or comply with 6.4, and include automatic monitoring at the system level.

- a) The monitoring shall generate a stop signal if a fault is detected. A warning shall be provided if a hazard remains after cessation of motion;
- b) Following detection of a fault, a safe state shall be maintained until the fault is cleared.
- c) Common mode failures shall be taken into account when the probability of such a failure occurring is significant.
- d) The single fault should be detected at time of failure. If not practicable, the failure shall be detected at the next demand upon the safety function.

4.6 Robot stopping circuits

Every robot shall have stopping functions providing for one or more **emergency stop** devices, and connection of external **safeguarding devices** which signal a stop. This shall include a **safety stop** circuit and an emergency stop circuit, with hardware based emergency stop output signal.

4.6.1 Emergency stop

The emergency stop shall be fully compliant with NFPA 79, override all other robot controls, cause all moving parts to stop, and remove drive power from the robot **actuators**.

NOTE – This may be a category 0 or category 1 type stop as required by NFPA 79.

4.6.2 Emergency stop devices

Each **operator** control station, including **pendants**, capable of initiating robot motion, shall have a manually initiated emergency stop device.

4.6.3 Emergency stop device design

Push-buttons that activate an emergency stop circuit shall be:

- a) red in color with a yellow background;
- b) unguarded;
- c) palm or mushroom head type;
- d) the type requiring manual resetting;
- e) installed such that resetting the button shall not initiate a restart.

4.6.4 Stopping with power off

The robot should support the capability, as an option, to include the supplied emergency stop devices in an externally powered circuit so that these devices remain capable of stopping external equipment even with the robot powered off.

4.6.5 Safety stop

Every robot shall have one or more safety stop circuits designed for the connection of external safeguarding devices.

While the robot is in **automatic mode**, the safety stop shall cause a stop of all robot motion, and remove power from the robot drive actuators. This stop may be initiated manually or by control logic using circuitry per 4.5.

4.7 Pendant and other teaching controls

Where a pendant control or other control device is provided to control the robot from within the **safeguarded space**, the requirements in 4.7.1 through 4.7.5 shall apply.

NOTE – This applies to any device used to control a robot from within the safeguarded space while drive power is applied to any of the robot axes. This includes robots with powered lead-through teach mode, whether using robot-mounted manual controls or main/secondary teaching controls.

4.7.1 Automatic

It shall not be possible to place the robot into automatic mode using the pendant or teaching control device exclusively.

4.7.2 Motion control

Motion of the robot initiated from the pendant or teaching control device shall be under **slow speed control** as described in 4.9. When high speed **attended program verification** per 10.8.3 is provided, the **robot system** shall meet the requirements in 4.8. All buttons and other devices on the pendant that cause robot motion shall stop motion when the button or device is released.

4.7.3 Enabling device

The pendant or teaching control device shall have an **enabling device** using a three position switch which, when continuously held in a detented position, permits motion. Release or compression past the midpoint detent of the device shall stop robot motion using circuitry consistent with 4.5.

NOTE – Tests have shown that human reaction to an emergency may be to release an object, or to hold on tighter, thus compressing an enabling device. Design and installation of the enabling device should consider the ergonomic issues of sustained activation. This is a requirement for new robots only. See 10.3 for information on existing systems.

4.7.4 Pendant emergency stop

The pendant or teaching control device shall have an emergency stop circuit as described in 4.6.

4.7.5 Single point of control

The robot control system shall be designed so that when the robot is placed under pendant control or other teaching device control, initiation of robot motion shall be prevented from any source except the selected control device.

4.8 High speed APV requirements

When the capability to initiate motion at speeds greater than 250 mm (10 inches)/sec is provided for high speed attended program verification per 10.8, the robot shall meet the following requirements:

- a) have a means to select APV mode requiring a deliberate action by the operator (e.g. a key switch on the robot control panel) outside of the safeguarded space;
- b) upon selection of APV mode, speed shall default to a speed at or below slow speed control limits;
- c) a means of adjusting the maximum speed up to the full programmed speed in several steps shall be provided on the pendant;

- d) an indication of the maximum speed selected shall be provided on the pendant;
- e) it shall require constant actuation of an enabling device and of the motion controls to continue robot motion.

4.9 Slow speed control

When operating in **coordinated motion** under slow speed control, the speed of the **tool center point** (TCP) shall not exceed 250 mm/sec (10 inches/sec).

When operating in joint mode under slow speed control, the maximum speed of the TCP at the full extension of the manipulator shall not exceed 250 mm/sec (10 inches/sec).

Slow speed control shall be designed and constructed so that in the event of any single reasonably foreseeable malfunction, the speed of the TCP shall not exceed the slow speed velocity limits.

4.10 Singularity protection

When in the **teach mode**, the robot control shall have the ability to stop robot motion and alert the **teacher** prior to the robot passing through or correcting for a **singularity** during coordinated motion initiated from the teach pendant.

4.11 Axis limiting devices

A means for installing adjustable mechanical stops shall be provided to limit the motion of the primary axis (the axis with the greatest displacement motion) of the robot. Provisions for mounting adjustable mechanical or non-mechanical **limiting devices** shall be provided for the next two axes (the axes with the second and third largest displacement motions). Mechanical stops shall be capable of stopping robot motion at rated load, maximum speed conditions, and at maximum and minimum extension. As an exception, if the primary axis is rotary, and the **maximum space** of the robot is a full circle (360°) adjustable mechanical limiting devices are not required on the primary axis.

Non-mechanical limiting devices include devices such as, but not limited to; 1) mechanical stops that are positioned electrically, pneumatically or hydraulically, 2) limit switches, 3) light curtains, 4) laser scanning devices and 5) pull cords when used to limit robot travel and define the **restricted space**.

NOTE – The adjustable devices allow the user to minimize the size of the restricted space. The degree of adjustment should be included in the required information in 4.16.

Mechanical stops include mechanical stops that are adjusted and then secured with fasteners.

Excluded from the axis limiting devices requirement are parallel link manipulators using cables or screw drives.

4.12 Provisions for lifting

Provisions for lifting the robot and its associated components shall be provided and shall be adequate for handling the anticipated load. These may include lifting hooks, eye bolts, threaded holes, fork pockets and the like.

4.13 Electrical connectors

Electrical connectors that could cause a hazard if they are separated, or if they break away, shall be designed and constructed so as to guard against such unintended separation. Those connectors that must be mated during installation of the robot and could cause a hazard if mismatched shall be provided with a means to prevent mismatching.

4.14 Hoses

If a failure of any hose could result in a hazard, such hose shall be secured, protected, or both.

4.15 Failures

Robots shall be designed and constructed so that any single reasonably foreseeable failure shall not cause a hazard.

4.16 Required information

The following information shall be provided for all robots and equipment furnished:

- a) Instructions/Procedures
 - 1) APV capability and use
 - 2) Emergency movement without drive power
 - 3) Emergency recovery procedure
 - 4) Lifting procedures and precautions
 - 5) Lockout procedures
 - 6) Operating instructions
 - 7) Slow speed control functional testing
 - 8) Start-up and testing procedures
- b) Warnings/Cautions
 - 1) Precautionary information
- c) Specifications/Technical Information
 - 1) Function and location of all controls
 - 2) Robot specifications including range and load capacity
 - 3) Information required for installation
 - 4) Limiting device information
 - 5) Number, location, and degree of adjustment of hard stop capability
 - 6) Stopping time and distance or angle (from initiation of stop signal at full rated speed, maximum extension and maximum load) of the three axes with the greatest displacement motion.
 - 7) The number and location of non-mechanical limiting devices, including implementation
 - 8) The number of enabling devices which are provided or capable of being provided and the information about what is needed and how to add any additional enabling devices
 - 9) The safety circuit performance the robot meets per 4.5.
- d) Certifications/Qualifications
 - 1) A list of the standards that the robot meets and a list of the standards that the robot is third party certified to meet
 - 2) Information on appropriate standards and related documents

- e) Maintenance
 - 1) Maintenance information, including preventative maintenance schedules
- f) System Requirements
 - 1) Electrical requirements
 - 2) Special environmental requirements including Electromagnetic Interference (EMI), Radio Frequency Interference (RFI) and Electro-Static Discharge (ESD)
- g) Miscellaneous Information (upon request)
 - 1) Failure mode analysis information
 - 2) Hazard analysis and description of all hazard controls (ANSI/UL 1740-1998 § 80, 81)
 - 3) Training materials

5 Performance requirements of safeguarding devices

5.1 Barrier guards, fixed and interlocked

Barriers shall:

- a) be constructed to withstand operational forces and environmental conditions;
- b) be free of sharp edges and projections and shall not themselves create a **hazard**;
- c) provide a means for secure attachment.

5.2 Interlocking safeguarding devices

Safeguarding devices which are used for **interlocking** shall:

- a) have a key, plug or actuating device which is not easily duplicated;
- b) be tamper resistant and not be defeated intentionally without tools;
- c) provide a means for secure attachment;
- d) be provided with documentation stating the standards that the product meets, the standards that the product is independently certified to meet, and their safety circuit performance per 4.5.

5.2.1 Mechanical devices

Mechanical devices (typically including, but not limited to, transfer or captive/trapped key interlocking, see figure B.3) shall:

- a) have a physical link between the **energy source** of a hazard and the locking mechanism so as to allow the removal of the key or actuating device only when the hazard has been controlled. The removal of the key or actuating device shall prevent reinstatement of the hazard;
- b) provide a mechanical lock for the guard at the point of access, which can only be unlocked by the key or actuating device described in (a). This lock shall trap or retain the key or actuating device when the guard is opened, and only release the key or actuating device when the guard is closed and locked;

5.2.2 Electrical devices

Electrical devices, with or without guard locking (including, but not limited to, safety switches, captive key systems, and magnetically actuated switches) shall:

- a) be provided with detailed information about the point in the travel of the actuating device where the switching action of the contacts occurs;

NOTE – Depending on the switch and the installation, the amount of travel before switching may differ significantly. For example, without the information a hinge mounted switch may be improperly installed such that the door could open and a person enter before switching occurs.

- b) be either: in compliance with 4.5.4, and upon failure detection successive **automatic operation** shall be prevented until the component failure has been corrected, or; be designed for positive opening (positive break) operation such that opening the contacts signals a stop (see figure B.4);

NOTE – Positive opening (positive break) operation is the full separation (opening) of a closed contact through a non-resilient linkage (e.g. not dependent on springs) due to movement from the home (engaged) position (see figure B.3.)

- c) guard locking devices hold the guard closed and locked until the hazard has ceased. These devices shall:
 - 1) provide a method to manually unlock the device in the event of power failure, and
 - 2) provide a method to monitor the state of the locking mechanism. The manufacturer shall separately state the safety circuit performance per 4.5, of the locking portion of the guard locking device.

5.3 Requirements for other safeguarding devices that signal a stop.

Safeguarding devices which initiate a stop signal shall:

- a) be accompanied with documentation stating the standards that the product meets, any standards that the product is independently certified to meet, and their safety circuit reliability per 4.5.
- b) provide a means for a readily observable indication that the device is operating;

NOTE – Indicators are not necessarily required on sensing component(s) (for example switches) that may be used to signal a stop or as inputs to a muting control.
- c) not be adversely affected by the environmental conditions for which the system is intended;
- d) have a maximum response time that shall not be affected by the object sensitivity adjustments or environmental changes;
- e) provide a means for secure attachment;
- f) provide a means to restrict unauthorized adjustments or settings (hardware/software).

NOTE – This may be accomplished by, but are not limited to the use of key-operated controls, controls located under lockable covers, passwords, etc.

5.3.1 Safety light curtains/screens

Safety light curtains/screens shall comply with requirements of 5.3 and additionally:

- a) be marked/labeled with:
 - 1) maximum response time
 - 2) maximum angle of divergence/acceptance at maximum gain

- 3) minimum object sensitivity
- 4) protected height;
- b) indicate if blanking is being used.
- c) provide for a method to prevent or detect unwanted reflections (e.g. optical short circuits).
 - NOTE – Methods can include the overall effective beam pattern, the overall angle of divergence/acceptance at maximum gain, or a test procedure to detect the occurrence.

5.3.2 Area scanning safeguarding devices

Area scanning **safeguarding** systems shall comply with requirements of 5.3 and additionally:

- a) be marked/labeled with:
 - 1) maximum response time;
 - 2) maximum safeguarding range;
 - 3) maximum field of view in degrees;
 - 4) range (linear and angular) and response time for an object sensitivity of 70 mm (2.75 inches);
- b) not present a hazard (e.g. comply with 21 CFR 1040.10 for eye safety in the case of lasers);
- c) have an identified total tolerance in the range measurement;
- d) provide an operating mode or method to allow the **user** to comply with 11.5e for verified detection area;
- e) provide information on the detection capabilities of the device in respect to the reflectivity of an object versus the distance to the object.

5.3.3 Radio frequency (RF)/capacitance safeguarding devices

RF/capacitance safeguarding devices shall comply with requirements of 5.3 and additionally:

- a) have a sensitivity adjustment to allow for authorized adjustment of the field by qualified personnel;
- b) not allow the adjusted field to decrease in sensitivity below the established level;
- c) be marked/labeled with:
 - 1) maximum response time, including output devices
 - 2) minimum object sensitivity at maximum range
- d) have an identifiable minimum object sensitivity and range that is not affected by ambient and environmental conditions.
- e) provide an operating mode or method to allow the user to comply with 11.6c for verified sensitivity setting.
- f) not be adversely affected by external fields (e.g. weld busses, portable hand-held VHF/UHF radios, or cellular telephones.)
- g) shall comply with FCC Rule 15 for sources of Electro Magnetic or Radio Frequency interference (EMI/RFI).

5.3.4 Safety mat systems

Safety mat systems consist of safety mat(s), wiring from the mat to the mat control, and a mat control.

- a) Safety mat controls shall:
 - 1) use system controls and wiring between the control and the mat complying with 5.3;
 - 2) be marked/labeled with maximum response time.
- b) Safety mats shall:
 - 1) be accompanied with documentation stating the standards that the product meets and any standards that the product is independently certified to meet;
 - 2) comply with the requirements of 5.3c-f;
 - 3) have an identifiable sensing field;
 - 4) have a minimum object sensitivity which detects 30 kg (66 lb.) weight on an 80 mm (3.125 inch) diameter circular disk anywhere on the mat sensing surface;
 - 5) provide a means to retain minimum object sensitivity at the area where two mats are intended to be joined together to form a single sensing surface, as measured above;
 - 6) be manufactured to prevent any reasonably foreseeable failures (i.e. oxidation of the contact elements) if such failure could cause a loss in sensitivity within the sensing field.

5.3.5 Single and multiple beam safety systems

Single and multiple beam safety systems shall comply with requirements of 5.3 and additionally:

- a) be marked/labeled with:
 - 1) maximum response time
 - 2) maximum angle of divergence/acceptance at maximum gain
 - 3) protected height and number/location of beams (fixed multiple systems only);
- b) only respond to its intended source of transmitted light or signal.
- c) provide for a method to prevent or detect unwanted reflections (e.g. optical short circuits).

NOTE – Methods can include the overall effective beam pattern, the overall angle of divergence/acceptance at maximum gain, or a test procedure to detect the occurrence.

5.3.6 Two hand control systems

Two hand control systems when used for **safeguarding** shall comply with requirements of 5.3 and additionally:

- a) be designed to prevent accidental or unintentional operation;
- b) have the individual **operator's** hand controls arranged by design, construction, or separation to require the use of both hands within 500 ms to **cycle the robot system**;
- c) be designed to require the release of all operator's hand controls and the re-activation of all operator's hand controls before a robot system cycle can be initiated;
- d) a stop signal shall be issued if one or both hands are removed from the controls during the hazardous portion of a cycle.

6 Installation of robots and robot systems

The **user** of **robots** or **robot systems** shall ensure that the robot systems are installed in accordance with 6.1 through 6.17 of this standard. **Safeguarding devices** shall be installed in accordance with clause 7.

6.1 Installation specification

The robots or robot systems shall be installed in accordance with the specifications of the robot manufacturer.

6.2 Environmental conditions

Environmental conditions shall be evaluated to ensure compatibility of the robot with the anticipated operational conditions. These conditions include, but are not limited to, explosive mixtures, corrosive conditions, humidity, dust, temperature, Electromagnetic Interference (EMI), Radio Frequency Interference (RFI) and Electro-Static Discharge (ESD).

6.3 Control location

Controls and equipment requiring access during **automatic operation** shall be located outside the **safeguarded space** so that a person using the control **actuators** shall be outside the safeguarded space. The location of robot controls and equipment shall be constructed to provide a view of the robot **restricted space** when applicable.

NOTE – When robot systems are designed to provide clear visibility to the point of operation or the area where work is performed, the likelihood of equipment and machinery being operated while another person is in a hazardous position is greatly reduced. This is not intended to diminish the need for lockout but rather to recognize that injuries may occur when more than one person is working around machinery.

6.3.1 Actuating controls

Actuating controls that initiate power or motion shall be constructed or located so as to protect against inadvertent operation.

NOTE – Examples include guarded push-button, key selector switch or two-handed control.

6.4 Safety related software and firmware based controllers

Software and firmware-based controllers used in place of hardware based components with safety-related devices shall:

- a) be designed such that any single safety related component or firmware failure shall:
 - 1) lead to the shutdown of the system in a safe state, and,
 - 2) prevent subsequent automatic operation until the component failure has been corrected;

NOTE – Firmware is that executive control program code provided by the manufacturer of the component in a non-volatile internal storage mode and is not changeable by the user.

- b) supply the same degree of safety achieved by using hardwired/hardware components per 4.5.4. For example, this degree of safety may be achieved by using microprocessor redundancy, microprocessor diversity, and self-checking;
- c) be certified by a Nationally Recognized Testing Laboratory (NRTL) to an approved standard applicable for safety devices.

6.5 Limiting devices

Limiting devices, when used, shall establish restricted spaces for restraint of motion of the robots. The limiting devices (10.2) shall not cause additional **hazards** in the safeguarded space.

Non-mechanical limiting devices include devices such as, but not limited to; 1) mechanical stops that are positioned electrically, pneumatically or hydraulically, 2) limit switches, 3) light curtains, 4) laser scanning devices and 5) pull cords when used to limit robot travel and define the restricted space. Non-mechanical limiting devices that do not physically stop robot motion shall be tested, after installation, to determine the boundaries of the restricted space when the device is actuated. Testing shall be performed under maximum speed and maximum anticipated load conditions at full extension. Control activated mechanical limiting devices that physically stop robot movement shall be engineered to meet the performance criteria of mechanical stops. The control circuit performance of non-mechanical limiting devices shall be Control reliable (4.5.4) unless a **risk assessment** is performed which indicates a lesser requirement. Testing methods and results must be documented.

NOTE – Mechanical stops include mechanical stops that are adjusted and then secured with fasteners.

When used as a limiting device, a non-mechanical device must be installed with consideration of load dimensions for depth penetration and stopping distance.

6.6 Restricted space identification

The restricted space should be conspicuously identified.

6.7 Dynamic restricted space

The **safeguarding interlocking** logic may be such that the restricted space is redefined as the robot performs its **task program**.

6.8 Robot system clearance

The robot system shall be installed to provide minimum clearance requirements as specified in 10.7.7 or 10.8.5. Existing systems shall comply with the standard in effect on the date of installation.

6.9 Power requirements

All sources of power provided shall meet the specifications of the manufacturer and applicable codes.

6.10 Grounding requirement

Electrical ground shall be provided in accordance with the specifications of the manufacturer and applicable codes.

6.11 Power disconnect

Each installation shall have a means to shut off power to the robot. This means shall be located outside the safeguarded space and shall have lockout/tagout capability.

6.12 Robot system stopping circuits

Every robot system shall have a system **emergency stop** circuit and a **safety stop** circuit. Safety stop circuits (including the robot) shall comply with the performance of 4.5.4 unless a risk assessment is performed and another performance criteria is determined per 9.5. This

requirement for two circuits is for new installations. No retrofit is necessary for existing installations.

6.12.1 Robot system emergency stop

The system emergency stop circuit shall be fully compliant with NFPA 79, shall override all other controls, cause all motion to stop, remove **drive power** from the robot actuators, and remove all other **energy sources** that may present a hazard.

NOTE – Additional energy sources may be present to energize process equipment or peripherals. Examples of energy sources may include, but not be limited to paint guns, welder power supplies, motion systems, heaters, and sealant applicators.

6.12.2 Robot system emergency stop device location

Each robot system **operator** work station and any locations capable of controlling motion shall be provided with a readily accessible, unobstructed emergency stop device.

6.12.3 Robot system emergency stop device design

Push-buttons that activate a system emergency stop circuit shall be:

- a) red in color with a yellow background;
- b) unguarded;
- c) palm or mushroom head type;
- d) the type requiring manual resetting;
- e) installed such that resetting the button shall not initiate a restart.

6.12.4 Robot work cell emergency stop function

- a) Red palm type or red mushroom head type push-buttons shall not be used for any function except stopping.
- b) Following an emergency stop, restarting automatic operation shall require a deliberate action to follow a prescribed start-up procedure outside the safeguarded space.
- c) If the restricted spaces of two or more robots overlap, or if two or more robots are accessible within a work cell without safeguarding between them, a common emergency stop circuit shall stop the robots and hazards within the work cell.
- d) Any stop device which does not stop all equipment in a common safeguarded area must be clearly labeled as a local stop and indicate what equipment is stopped.

6.12.5 Safety stops

While the robot system is in **automatic mode**, the safety stop shall cause a stop of all **hazardous motion**, remove power from the robot drive actuators, and cause all other hazards to cease. This stop may be initiated manually or by control logic. A separate circuit from the emergency stop circuit shall be used for safety stops initiated by the machine controller or safeguarding devices which signal a stop.

NOTE – This type of stop allows an orderly stop which retains the program logic for troubleshooting purposes and to facilitate a restart. Power may be restored to single station components such as robots, lifters, clamps, slides, dumps, etc. for manual cycling, jogging, or teaching.

6.13 Associated equipment shutdown

The robot system shall be installed so that shutdown of associated equipment shall not result in a hazard.

6.14 End-effector power loss or change

End-effectors shall be designed and constructed so that loss or change of electrical, hydraulic, pneumatic or vacuum power shall not result in a hazard. If this is not feasible, then other methods of safeguarding shall be provided to protect against hazards.

6.15 Emergency recovery procedure

Directions shall be provided for the emergency movement without drive power for the robot mechanisms and for other foreseeable fault recovery of related equipment.

6.16 Precautionary labels

Where precautionary labels provided on the robot are not visible due to some application or process, other means of precautionary notice shall be provided.

6.17 Required information

The applicable information as listed in 4.16 for robots shall be provided for all robot systems.

7 Safeguarding of personnel – Introduction

7.1 Responsibility

Safeguarding personnel against **hazards** which could cause personal injury is the responsibility of all persons involved in the design, integration, and use of **robots** and **robot systems**. The **user** shall ensure that appropriate **safeguarding devices** are in place, functioning, and that personnel are trained to use them as intended.

7.2 Implementation

Safeguarding shall be implemented by installing the appropriate safeguarding devices necessary to provide a safe working environment for personnel. Eliminating hazards by design changes in the application is preferred to the use of engineering controls (figure A.2). The work space should be designed for efficient production, enable personnel to accomplish their jobs in a safe manner, and remove the motivation to bypass safety controls.

7.3 Robot or robot system implementation stages

Safeguarding shall be required at each of the different development, implementation, and operational stages of robots and robot systems including but not limited to:

- a) design/development
- b) integration/installation
- c) verification/testing
- d) production operation
- e) maintenance

- f) training
- g) research and development
- h) re-application

7.4 Sources of hazards

Hazards shall be identified in all aspects of the installation, including but not limited to:

- a) equipment (robots, **safeguards**, ancillary hardware);
- b) installation (pinch points, mounting, positioning);
- c) process hazards which arise from the robot system itself, from its association with other equipment, or from interaction of persons with the robot system.

NOTE –Examples of sources of hazards are, but not limited to, the following:

- moving mechanical components causing trapping or crushing; individually (by themselves), in conjunction with other parts of the robot system, or other equipment in the work area
- stored energy in: moving parts; electrical, air or fluid power components;
- power sources: electrical; hydraulic; pneumatic
- hazardous atmospheres, materials, or conditions: explosive or combustible; radioactive; extreme high or low temperature
- noise (acoustical)
- interference: electromagnetic, electrostatic, radio frequencies; vibration and shock;
- loose objects, projectiles (e.g. failures of fixtures, grippers, or other mechanical parts retention devices)
- ergonomics
- slips, trips and falls from same level and from elevated locations
- human errors in: design, development and construction including ergonomic considerations; installation and commissioning including access, lighting, and noise; functional testing; application and use; programming and program verification; set-up including work handling/holding and tooling; troubleshooting and maintenance; safe working procedures;
- moving, handling, or replacing of the robot system or associated components.
- failures or faults of: protective means (e.g. devices, circuits, components), including removal or disassembly; power sources or means of distribution; control circuits, devices or components including input and output devices or circuits;
- inadvertent operation caused by equipment failure
- actions by personnel, either unintended or deliberate

7.5 Safeguarding methodology selection

A safeguarding strategy shall be developed for identifying and controlling hazards, including process-specific hazards (7.4), and **either**:

- a) installing the safeguards required in clause 8, and installing them in accordance with clause 10;
- or**
- b) conducting a comprehensive **risk assessment** per clause 9, and installing the safeguards determined to be appropriate in accordance with clause 10.

8 Safeguarding of personnel – Prescribed method

The following **safeguards** are prescribed and shall be installed in accordance with clause 10 when a **risk assessment** is not performed.

8.1 Safeguarding requirements

The **robot** and **robot system** shall be equipped with adequate **safeguarding devices** to protect against **hazards**, including, but not limited to, the hazards as described in 7.4. **Safeguarding** shall be by means which prevents access to the hazard, or cause the hazard to cease, without a specific conscious action by the person(s) being protected. Safeguarding devices shall have control reliable control circuitry (4.5.4) and be installed and applied consistent with clause 10. Designated procedures and training shall be used as described in clause 14. Additionally, **awareness barriers** and **awareness signals** should be used to augment safeguarding devices.

8.2 Restricted space

The **restricted space** shall be established by installation of **limiting devices** which minimize the total distance a robot can travel per 10.2. Protection outside the restricted space shall be by perimeter guarding which establishes the **safeguarded space**. In no case shall the perimeter guarding be installed closer to the hazard than the restricted space.

NOTE – Design layout should minimize the difference between the operating space and the restricted space.

8.3 Protection of personnel outside the safeguarded space

Personnel shall be protected from hazards that are within the safeguarded space by:

- a) Containing all process hazards;
- b) preventing access into the safeguarded space and, when access is required, stopping all motion within the safeguarded space upon entry by use of **interlocked barriers** and/or **presence-sensing safeguarding devices**;
- c) Application of appropriate **operator** interface safeguarding devices such as interlocked barriers and/or presence-sensing safeguarding devices.

8.4 Protection of personnel within the safeguarded space

Personnel required to perform tasks within the safeguarded space shall be protected by:

- a) Preventing the re-initiation of any motion or hazardous process while personnel are within the safeguarded space, for example locking a gate open;
- b) Providing clearance in accordance with 10.8.5;
- c) Limiting motion to slow speed per 4.9 or be in compliance with APV requirements in 10.8;
- d) Compliance with the **teach** requirements in 10.7.5, and;
- e) Compliance with the safeguarding maintenance personnel requirements in 10.10.

8.5 Point of operation hazards

Protection from **point of operation** hazards shall be provided by use of additional safeguarding devices within the safeguarded space.

NOTE – Point of operation hazards are usually a function of the robot end-effector. Weld flash, spraying processes, grinding, deburring, processes using ionizing and non-ionizing radiation, and dipping are some of the examples of processes that may present

hazards to operators, maintenance, teachers or other personnel in proximity to the restricted space. Safeguarding methods described in 10.4, used in conjunction with process specific protective devices and sound industrial hygiene practices should afford optimal protection for personnel subject to exposure.

9 Safeguarding of personnel – Risk assessment method

When required by 7.5 for new installations, a **risk assessment** shall be performed. The risk assessment shall take into account the stage of development, intended use of the **robot** and **robot system**, anticipated skill and training of **operators**, additional **risk** exposure and processes. A number of methodologies are available to do a risk assessment. Any method is acceptable which prescribes **safeguarding** equivalent to or more stringent than the requirements of this clause.

9.1 Requirements

- a) The risk assessment shall be performed by the **user** or integrator at the time of initial robot and robot systems design to determine minimum safeguarding requirements and to develop an overall safety strategy (see figure C.1). This assessment shall be revised and updated as the design process matures prior to installation of the robot system.
- b) Additional risk assessments shall be performed by the user upon final installation and configuration, and again each time the system configuration changes. The user shall maintain the documentation of the most recent risk assessment(s).
- c) The first step of a risk assessment shall assume no **safeguards** are installed and include:
 - 1) task and **hazard** identification per 9.2;
 - 2) risk estimation per 9.3;
- d) The second step of a risk assessment shall select the safeguards based on requirements of 9.4 and 9.5.
- e) The third step of the risk assessment is to assume the safeguards are installed and validate the selection (9.6).

NOTE – Annex C offers an example of a risk assessment method which has been demonstrated to achieve the required results.

9.2 Task and hazard identification

- a) Describe the application/process and a definition of the limits associated with its intended use;
- b) Identify all reasonably foreseeable tasks associated with the robot and robot system and the stage of development;
- c) Identify hazards associated with each task, except the special requirements associated with **teach** (ref. 10.7.4).

9.3 Risk estimation

For each task and hazard combination, determine level of risk using severity, exposure, and avoidance per table 1. Where multiple criteria can apply, use the most restrictive criteria.

Factor	Category		Criteria
Severity	S2	Serious Injury	Normally irreversible; or fatality; or requires more than first-aid as defined in OSHA §1904.12
	S1	Slight Injury	Normally reversible; or requires only first-aid as defined in OSHA §1904.12
Exposure	E2	Frequent exposure	Typically exposure to the hazard more than once per hour (see note below).
	E1	Infrequent exposure	Typically exposure to the hazard less than once per day or shift (see note below)
Avoidance	A2	Not Likely	Cannot move out of way; or inadequate reaction time; or robot speed greater than 250 mm/sec
	A1	Likely	Can move out of way; or sufficient warning/reaction time; or robot speed less than 250 mm/sec

Table 1 – Hazard Severity/Exposure/Avoidance Categories

NOTE – Exposure can be affected by either a change in the frequency that the task is performed or by the application of a category R2 risk reduction safeguard or application of lockout to control the hazard by removal of the energy source that reduces exposure to the hazard. Determining frequency of access can require judgment decisions by the person(s) performing the risk assessment. Access can range from cyclical production to maintenance tasks associated with periodic maintenance. When determining proper safeguards, it should be noted that serious injuries have resulted from infrequent tasks.

Avoidance can be affected by: a) reducing the speed of the hazard to give sufficient warning/reaction time, or b) through the application of a category R2 risk reduction safeguard, or c) installation of awareness devices.

9.4 Risk reduction determination

Using the Avoidance, Severity and Exposure criteria for each task and hazard combination obtained from table 1, follow across table 2 to determine the risk reduction category.

SEVERITY OF INJURY	EXPOSURE	AVOIDANCE	RISK REDUCTION CATEGORY
S2 Serious Injury More than First-aid	E2 Frequent exposure	A2 Not Likely	R1
		A1 Likely	R2A
	E1 Infrequent exposure	A2 Not Likely	R2B
		A1 Likely	R2B
S1 Slight Injury First-aid	E2 Frequent exposure	A2 Not Likely	R2C
		A1 Likely	R3A
	E1 Infrequent exposure	A2 Not Likely	R3B
		A1 Likely	R4

Table 2 – Risk reduction decision matrix prior to safeguard selection

NOTE – This table assumes that no safeguards are installed.

9.5 Safeguard selection

Using the risk reduction category determined by table 2, follow across table 3 to determine the minimum required safeguard performance and circuit performance. When **attended program verification** (APV) is to be used, the selection of safeguards shall be as required in 10.8.

CATEGORY	SAFEGUARD PERFORMANCE	CIRCUIT PERFORMANCE
R1	Hazard elimination or hazard substitution (9.5.1)	Control reliable (4.5.4)
R2A	Engineering controls preventing access to the hazard, or stopping the hazard (9.5.2), e.g. interlocked barrier guards, light curtains, safety mats, or other presence sensing devices (10.4)	Control reliable (4.5.4)
R2B		Single channel with monitoring (4.5.3)
R2C		Single channel (4.5.2)
R3A	Non-interlocked barriers, clearance, procedures and equipment (9.5.3)	Single channel (4.5.2)
R3B		Simple (4.5.1)
R4	Awareness means (9.5.4)	Simple (4.5.1)

Table 3 – Safeguard Selection Matrix

NOTE – Application of the Safeguard Selection Matrix (Table 3) and Safeguard Selection Validation Matrix (Table 4) are primarily intended for machinery and equipment related task and hazard combinations. Certain task and hazard combinations such as material related tasks that include exposure to sharp parts, thermal and ergonomic hazards require the application of the highest level of feasible safeguarding based on the hierarchy of controls (table A.2) and fall outside the scope of Tables 3 and 4. Appropriate standards and regulations should also be consulted.

9.5.1 Category R1 risk reduction

Risk reduction shall be accomplished by hazard elimination or hazard substitution which does not create an equal or greater hazard. When hazard elimination or substitution is not possible, all provisions of a category R2 risk reduction shall apply and provisions of categories R3 and R4 shall be used for safeguarding **residual risk**.

9.5.2 Category R2 risk reduction

Safeguarding shall be by means that prevent access to the hazard, or cause the hazard to cease. Provisions of categories R3 and R4 may be used for safeguarding residual risk.

9.5.3 Category R3 risk reduction

Safeguarding, at a minimum, shall be by means of **non-interlocked barriers**, clearance from the hazard, written procedures, and personal protective equipment if applicable. Provisions of Category R4 may also be used for safeguarding residual risk.

9.5.4 Category R4 risk reduction

Safeguarding, at a minimum, shall be by administrative means, awareness means including audio/visual warnings and training.

9.6 Selection validation

Once safeguards are selected based on table 3 requirements and installed in accordance with clause 10, the process in 9.2 and 9.3 must be repeated to determine if each identified hazard has been protected so that the remaining risk is tolerable. Re-evaluate the Avoidance, Severity and Exposure criteria for each task and hazard combination using table 1. Then follow across table 4 to determine the risk reduction category. Apply the appropriate additional safeguards to control residual risk. If the risk reduction category is now an R3 or R4, the risk reduction for that task and hazard combination is complete. If the risk reduction category is not an R3 or R4, install appropriate safeguards and repeat this step.

EXPOSURE	AVOIDANCE	SEVERITY OF INJURY	RISK REDUCTION CATEGORY
E 2 Frequent exposure	A2 Not Likely	S2 Serious Injury	R1
		S1 Slight Injury	R2C
	A1 Likely	S2 Serious Injury	R2A
		S1 Slight Injury	R3A
E1 Infrequent exposure	A2 Not Likely	S2 Serious Injury	R2B
		S1 Slight Injury	R3A
	A1 Likely	S2 Serious Injury	R3B
		S1 Slight Injury	R4

Table 4 – Safeguard selection validation matrix with safeguards installed

9.7 Documentation

The risk assessment will be documented at each stage of system development. The user shall maintain a file documenting the most recent risk assessment(s) for each robot or robot system in use (see annex C for sample formats). At a minimum the file must contain lists of tasks, hazards, risk reduction category, and safeguards selected, to validate and record the risk assessment requirements of 9.1 through 9.6. This assessment will be passed on to the successor level responsible for installation/integration; and be incorporated in the risk assessment accomplished at the next stage.

10 Safeguarding of personnel – Implementation

10.1 Requirements of safety circuit performance

The ultimate design requirement for safety systems is that, should they fail, the associated **hazard** is left in a safe state. Safety related parts of control systems shall be designed, constructed, selected, and assembled using basic safety principles for the intended application and can withstand:

- a) the expected operating stresses
- b) the influence of the processed material
- c) other relevant external influences.

The performance criteria listed in 4.5 shall be used in the design of the safety circuit consistent with the associated level of hazard. These circuit requirements are for new installations.

10.2 Limiting robot motion

Limiting **robot** motion may be accomplished by means integral to the robot, or by external **limiting devices**. Limiting devices are used to re-define the **space** for a robot to perform its task, e.g. the **restricted space** is made smaller than the **maximum space** by installation of limiting devices.

10.2.1 Mechanical limiting devices

Mechanical limiting devices, including mechanical stops integral to the robot, shall be capable of stopping motion at rated load, maximum speed conditions, and at maximum and minimum extension for the device.

10.2.2 Non-mechanical limiting devices

Devices such as, but not limited to, limit switches, relays or blocking valves may be utilized provided the device and associated controls (hardware based or compliant with 6.4) are capable of stopping the robot motion under maximum load and speed conditions. Non-mechanical limiting devices shall be electrically integrated in accordance with 10.4.6.

10.2.3 Dynamic limiting devices

Dynamic limiting is the automatically controlled change in a robot's restricted space during a portion of the **robot system's cycle**. Control devices such as, but not limited to, cam operated limit switches, light curtains or control activated retractable hard stops may be utilized to further limit robot movement within the restricted space while the robot performs its **task program** provided the device and associated controls (hardware based or compliant with 6.4) are capable of stopping the robot motion under rated load and speed conditions. Dynamic limiting devices shall be electrically integrated in accordance with 10.4.6.

10.3 Pendants

10.3.1 New installations

Pendants or teaching control devices used inside the **safeguarded space** shall conform to 4.7.

10.3.2 Existing installations

Existing pendants or teaching control devices used inside the safeguarded space and not equipped with an **enabling device** or function must be retrofitted. Retrofit to the three position switch is not required, and should not be done unless the installation is ergonomically accomplished. Pendants with a motion function which requires continuous activation to allow robot motion also meet the intent of this requirement.

10.4 Safeguarding devices - application, integration and installation requirements

10.4.1 Purpose of safeguarding devices

Safeguarding devices shall be used consistent with the manufacturers instructions; and shall be applied to the robot system to:

- a) prevent access to the hazard,
- b) cause the hazard to cease before access,
- c) prevent unintended operation,
- d) contain parts and tooling (e. g. loose objects, flying projectiles).

- e) control other process hazards (e. g. noise, laser, radiation.)

NOTE – Each safeguarding device may not address each criteria a-e, depending on the hazard being protected.

10.4.2 Safeguarding device selection

Devices selected for **safeguarding** robot and robot systems applications shall comply with the requirements contained in clause 5. The selection of the safeguarding devices or combination of devices shall provide automatic protection against hazards associated with tasks such as normal production, teaching, troubleshooting, and maintenance. Safeguarding shall be accomplished by the use of one or more of the following safeguarding devices:

- a) **barriers**, fixed and **interlocked**;
- b) two hand control systems;
- c) **presence sensing safeguarding devices (PSSD)**:
 - 1) safety light curtains/screens
 - 2) safety mat systems
 - 3) area scanning safeguarding systems
 - 4) radio frequency (RF)/capacitance sensing safety systems
 - 5) single and multiple safety beams

Barrier Opening Size (Smallest Dimension)		Minimum Distance from Hazard	
mm	inches	Slotted opening	Square opening
0.0 - 6.0	0.000 - 0.250	≤13.0 mm ^A 0.5 in	≤13.0 mm ^A 0.5 in
6.1 - 11.0	0.251 - 0.375	≤64.0 mm 2.5 in	≤48 mm 1.9 in
11.1 - 16.0	0.376 - 0.625	≤89.0 mm 3.5 in	≤66 mm 2.6 in
16.1 - 32.0	0.626 - 1.250	≤166.0 mm 6.5 in	≤166.0 mm 6.5 in
32.1 - 49.0	1.251 - 1.875	≤445.0 mm 17.5 in	≤445.0 mm 17.5 in
49.1 - 132.0 ^B	1.876 - 5.000 ^B	≤915.0 mm 36.0 in	≤915.0 mm 36.0 in

Table 5 – Minimum distance from hazard as a function of barrier opening size³

NOTE – This criteria is for new installations only.

³ Based on data presented in *Applied Ergonomics*, Vol. 26, No 22, p.p. 141-145, *A Review of Machine-Guarding Recommendations*, Donald R. Vaillancourt & Stover H. Snook, The Liberty Mutual Research Center For Safety and Health; and Standard Drawing 2063-2, ©1998 Liberty Mutual Group. Used with permission.

A - Barriers shall not be located less than 13.0 mm (0.5 inches) from the hazard.

B - Barrier openings shall not be greater than 132.0 mm (5.0 inches) unless a risk assessment is performed.

10.4.3 Safeguarding device safety distance

All safeguarding devices shall be securely installed and located at a distance such that the hazard can not be accessed.

- When preventing access with barriers, table 5 shall be used to determine the minimum safe distance for fixed barriers with openings. See figure B.1 for graphical representation of this table.
- When signaling the hazard to cease with interlocked devices (including access points in fixed barrier guarding), two hand controls, or presence sensing safeguarding devices, the formula in table 6 shall be used to determine the minimum safe distance.
- When presence sensing safeguarding devices are used solely to prevent starting or restart, or safeguarding for clearance, safety distance is not a requirement but the devices must be positioned to comply with 10.7.7 or 10.8.5.

NOTE – When PSSDs solely safeguard against start or restart hazards, other safeguarding devices are used to prevent access or cause the hazard to cease before access.

$$D_s = [K \times (T_s + T_c + T_r)] + D_{pf}$$

where:

D_s = minimum safe distance between safeguarding device and the hazard

K = speed constant: 1.6 m/sec (63 inches/sec) minimum based on the movement being the hand/arm only and the body being stationary

NOTE – A greater value may be required in specific applications and when body motion must also be considered.

T_s = worst stopping time of the machine/equipment

T_c = worst stopping time of the control system

T_r = response time of the safeguarding device including its interface

NOTE – T_r for interlocked barrier may include a delay due to actuation. This delay may result in T_r being a deduct (negative value).

D_{pf} = maximum travel towards the hazard within the presence sensing safeguarding devices (PSSD) field that may occur before a stop is signaled. Depth penetration factors will change depending on the type of device and application. See figure B.2 for specific values.

Table 6 – Minimum distance from hazard for a device which signals a stop

10.4.4 Bypassing safeguarding devices

Bypassing refers to the manual interruption of the normal function of a safeguarding device that signals or causes a stop by designed-in controls or by temporary means.

- Bypassing in **automatic mode** - The robot system shall not be operated in automatic mode with any of the **safeguards** bypassed unless alternate safeguards are provided which provide an equivalent level of protection from the hazard.

- b) Bypassing for maintenance - When a means to bypass safeguarding devices is provided for maintenance, the following requirements shall be met:
 - 1) for designed-in bypass controls, it shall not be possible to resume **automatic operation** with the bypass activated.
 - 2) the bypass means shall be located in clear view of the device bypassed.
 - 3) the bypass control shall be designed and installed consistent with the circuit performance of the device being bypassed.
 - 4) visual indication that safety devices are bypassed shall be provided at the bypass control, the cell maintenance entrance, and the affected **operator** stations, if any.
- c) Bypassing for teach - When a control device to bypass safety devices is provided for **teach**, the following requirements shall be met:
 - 1) it shall not be possible to resume automatic operation with the bypass control device activated.
 - 2) the **teacher** shall be fully trained in which safeguarding devices have been bypassed.
 - 3) the bypass control shall be designed and installed consistent with the circuit reliability of the device being bypassed.
 - 4) visual indication that safety devices are bypassed shall be provided at the bypass control, the cell maintenance entrance, and the affected operator stations, if any.

10.4.5 Muting

Muting is the temporary automatically controlled deactivation of the function of a safeguarding device during a portion of the robot, or robot system's cycle. Muting may be used in conjunction with any safeguarding device that electrically signals a stop. (See figure B.5)

Muting is permitted when:

- a) personnel are not exposed to the hazard;
- b) the hazard cannot be accessed without a stop being initiated;
 - NOTE – Physical barriers or obstructions can prevent access.
- c) the muting system is designed and installed consistent with the safety circuit performance required of the device being muted. In the event of a failure subsequent muting shall be prevented until the failure is corrected.
- d) for operator interface application(s), presence in the muted safeguarded space is continually sensed;

NOTE – Continual sensing is typically meant for parts loading applications where personnel are expected to enter an area protected by a safeguarding device which is muted and then exit prior to the next cycle in the safeguarded space. Muting to allow the entry of a part requires alternative sensing to detect personnel intrusion, but is not required to detect deliberate acts such as riding inside a car body.

10.4.6 Safeguarding device electrical integration

Safeguarding devices shall be integrated into the **safety stop** circuitry:

- a) per 10.1 and 4.5.4, or
- b) per table 3 if a **risk assessment** per clause 9 is performed.

10.4.7 Start and Restart

Personnel shall be protected from inadvertent start/restart of the robot or robot system when they are inside the safeguarded space. Restart shall require deliberate actions outside the safeguarded space. Where start and restart of the cell does not provide for clear view of the safeguarded space, a method for detection of personnel in the non-observable location(s) is required. The preferred method is automatic detection. When automatic detection is not provided, alternative methods shall be provided which include but are not limited to:

- a) procedural policy/programs
- b) awareness means
- c) visual/audible warnings
- d) training

10.5 Awareness means

Awareness means include barriers or signal devices used to call attention to the existence of potential hazards. They should be used in addition to, but shall not be as a substitute for, the safeguarding devices in clause 11. Awareness means shall be used to identify **residual risks** not protected by other safeguards.

NOTE – Where the hazards cannot be totally or physically removed or controlled by design, awareness means should be used. Awareness means are not intended to be used in place of engineering controls, such as barriers and presence sensing safeguarding devices.

10.5.1 Awareness barrier

An **awareness barrier** shall be constructed, located, and installed so that a person cannot enter the restricted space of a robot without sensing the presence of the barrier.

10.5.2 Awareness signal

An **awareness signal** shall be constructed and located such that it shall provide a recognizable audible or visual signal to individuals of an approaching or present hazard. When visual awareness light signals are used to warn of hazards within a safeguarded space, they shall be designed and located so that the light can be seen by an individual approaching the safeguarded space. Audible awareness devices shall have a distinctive sound and a greater decibel level than the surrounding ambient noise.

10.6 Procedures and training

Procedures and training shall be used in addition to, but not as a substitute for, the safeguarding devices in clause 11.

10.7 Safeguarding the teacher

The teacher is the person assigned to “teach”, manipulate, or **program** the robot. When teaching requires personnel inside the safeguarded space, safeguards are required to protect the teacher from hazards.

10.7.1 Training

The **user** shall ensure that the teacher is trained in accordance with clause 14.

10.7.2 Preparation

Before teaching a robot, the teacher shall visually check the robot and safeguarded space to ensure that conditions which may cause hazards do not exist. The **emergency stop** and motion controls of the pendant shall be functionally tested to ensure proper operation. Any damage or malfunction shall be repaired prior to commencing the teaching operation.

10.7.3 Functional safeguards

Before entering the safeguarded space, the teacher shall ensure that all safeguards are in place and functioning as intended in the **teach mode**.

10.7.4 Protection from adjacent hazards

The teacher shall be safeguarded from the motion of adjacent robots and other associated equipment that may present a hazard.

10.7.5 Selecting teach mode

When the teach mode is selected, the following conditions shall be met:

- a) the teacher shall be provided with and use a pendant which has **single point of control** of the robot (10.3);
- b) when operating under **drive power, slow speed control** shall be in effect (see 4.9). The actual speed shall be selected such that the teacher has sufficient time to either withdraw from **hazardous motions** or stop the robot. The teacher must exercise caution when operating in coordinated straight line mode since the robot is controlling the **tool center point** and a greater speed may exist at other parts of the robot or axis while in motion;
- c) all robot system emergency stop devices shall remain functional;
- d) during teaching, only the teacher should be allowed in the restricted space. Certain teaching/programming situations may require more than one person in the safeguarded or restricted space. The teacher shall have sole control of robot motion in accordance with 10.7.5a.
 - 1) additional personnel within the restricted space shall be furnished with and use an enabling device consistent with 4.7.3,or
 - 2) be protected by providing the clearance and safeguarding requirements in 10.8.5. In addition, safeguarding shall be added when the potential rear swing or side motion of robot components such as the shoulder, counterweight, drives or accessory structures create a pinch point to adjacent equipment; and any robots having overlapping restricted spaces shall be prevented from simultaneous teaching capability by hardware based circuitry.
- e) the teacher shall have sole control of movement of other equipment in the safeguarded space if such movement would present a hazard;
- f) where there is more than one robot in the safeguarded space, automatic operation shall be inhibited on all robots if a barrier interlock has been opened or a presence sensing device perimeter guard has been violated.

10.7.6 Automatic mode

All personnel shall be required to leave the safeguarded space prior to initiating automatic mode.

10.7.7 Clearance

When personnel must enter the safeguarded space to perform the slow speed teach function, in robot cells without **attended program verification** (APV) high speed capabilities, the robot system shall be installed to provide a minimum clearance from the **operating space** of 0.45 m (18 inches) from areas of building, structures, utilities, other machines and equipment not specifically supporting the robot function that may create trapping or a pinch point. Where this minimum clearance is not provided, additional safeguarding devices to stop robot motion while personnel are within 0.45 m of the trapping or pinch hazard shall be provided. This does not include those areas that are not readily accessible except by climbing over, around or under an obstruction unless access is required for the teaching function. See figure A.2 for graphical representation.

10.8 Safeguarding personnel during program verification

Program verification is a method to confirm that a robot's programmed path and process performance are consistent with the expectations for the application. Verification may include the total **program path** or a segment of the path. It is used in new applications and in fine tuning/editing of existing ones.

NOTE – Program verification shall be performed outside the safeguarded space whenever possible. APV shall not be used for continuous production of parts/process.

Program verification includes the following methods:

10.8.1 Verification from outside the safeguarded space

Personnel shall be protected in this mode by the safeguarding specified in section 8.3.

10.8.2 Slow speed attended program verification

Program execution in slow speed (4.9) verification shall not exceed one cycle. Additional cycles shall require re-initiation of the program. In addition all the requirements described in 10.7 shall apply.

10.8.3 High-speed attended program verification

Certain robot applications may require a person to be present inside the safeguarded space to verify the robot's programmed task and its interaction with other equipment at speeds exceeding the slow speed control limit. This operation is defined as high speed attended program verification (APV).

NOTE – In order to keep personnel outside the safeguarded space, consideration should be given to using alternate means for inspection of the task program. Means may include, but not be limited to work cell design, cameras, and mirrors, and any other means that afford a view of the robot program execution.

10.8.4 Requirements for high speed APV

The following safeguarding requirements shall apply during high speed attended program verification:

- a) the robot system shall be installed with safety circuit performance in accordance with 4.5.4. Existing systems not complying with circuit performance of 4.5.2 should be retrofitted to at least that performance level;
- b) selection of attended program verification shall require deliberate action as defined in section 4.8;
- c) the person shall be trained in accordance with clause 14;

- d) the robot system shall be installed so that it cannot be placed in automatic mode when high speed attended program verification is selected.
- e) For multi-robot cells, only the minimum number of robots to verify the program shall be operated at high-speed APV at one time. For existing installations, compliance with 6.12.4c is also required.
- f) only one person shall be allowed within the safeguarded space;
NOTE – A means to prevent or warn against additional personnel entering the safeguarded space shall be provided.
- g) before initiating high speed APV, the person shall visually check the robot and safeguarded space to ensure that conditions which may cause hazards do not exist. The emergency stop and motion controls of the pendant shall be functionally tested to ensure proper operation. Any damage or malfunction shall be repaired prior to commencing the verification operation;
- h) before entering the safeguarded space, the person shall ensure that all safeguards are in place and functioning as intended in the teach mode;
- i) person performing attended program verification shall use a pendant complying with 10.3;
- j) person performing attended program verification shall remain outside of the programmed path being verified;
NOTE – That means that the person shall not have to move to stay out of the path of the robot, including the unpredictable swing arc of a possible singularity.
- k) APV shall be restricted to the minimum amount of motion necessary for verification;
NOTE – Speed defaults to slow speed control limits when APV is selected (4.8).
- l) the first test cycle shall be at slow speed;
- m) speeds shall be selectively increased in several steps by the operator;
- n) program verification for one cycle only. Additional cycles shall require reinitiation of the program;
- o) disable other robots or equipment in the safeguarded space which are not required to move during the process being verified ;
- p) the person shall be required to leave the safeguarded space prior to initiating automatic mode.

10.8.5 Clearance for high speed APV

When attended program verification in high speed is used or when referenced here by other clauses, the robot system shall be installed to provide a minimum clearance from the restricted space of 0.45 m (18 inches) from readily accessible areas of buildings, structures, utilities, other machines and equipment not specifically supporting the robot function that may create trapping or a pinch point. Where this minimum clearance is not provided, additional safeguarding devices to stop robot motion while personnel are within 0.45 m of the trapping or pinch hazard shall be provided. See figure A.2 for graphical representation.

10.9 Safeguarding the operator

The user of a robot system shall ensure that safeguards are established for each operation associated with the robot system. Special care should be exercised where an operator is required to interact with the robot on each operating cycle such as to feed parts to the robot for processing, the user of the robot system shall assure that safeguards are established for each operation.

10.9.1 Requirements

- a) Operators of robot systems shall be trained in accordance with clause 14.
- b) Operators shall be instructed in the proper operation of the control **actuators** for the robot system and shall be instructed in how to respond to recognized hazards.
- c) Operators shall be safeguarded either in accordance with clause 8 or by implementing the safeguards determined by a risk assessment in accordance with clause 9.
- d) The safeguards shall either prevent the operator from being in the restricted space during automatic robot operation or stop robot motion while any part of an operator's body is within the restricted space.

10.9.2 Presence sensing device initiation (PSDI)

PSDI is the mode of operation when a PSSD still acts as a safeguarding device, but it is also used in a control configuration such that PSSD interruptions are monitored so that the control initiates a cycle start when the sensing field is clear without the need of pressing any additional cycle enable or run buttons.

The following additional requirements shall be met when a presence sensing safety device is used to signal a start action in addition to its safeguarding function:

- a) PSDI shall be used for production operations only. Setup, teaching, and maintenance shall not be done in the PSDI mode;
- b) a configuration which would allow a person to enter, pass through towards the hazardous area and become clear of the PSSD's sensing field shall not be used in a PSDI mode of operation;

NOTE - Careful consideration should be given if PSDI is to be used in the horizontal sensing plane.

- c) PSDI shall comply with the following:
 - 1) selection of PSDI shall require a separate and deliberate act;
 - 2) a timer shall be provided to deactivate PSDI should there be a delay between production initiations;
 - 3) part in place sensing shall be used, such that the part/work piece is in-place in order for PSDI to operate;
 - 4) PSDI shall provide safeguarding on one plane only, mirrors shall not be used;
 - 5) light curtains used for PSDI operation shall have a minimum object sensitivity not to exceed 30 mm (one and one-fourth inches). Where light curtain object sensitivity is user-adjustable, either discretely or continuously, design features shall limit the minimum object sensitivity adjustment not to exceed 30 mm. If Fixed Blanking is used, then the blanked area shall be completely obstructed. Floating Blanking shall not be used if the minimum object sensitivity exceeds 30 mm in such use;
 - 6) when the PSSD signals a safety stop command for safeguarding purposes (i.e. stopping the robot system cycle), a manual or conscious act shall be required to re-initiate the robot system cycle;
- d) all other access to the hazard shall be prevented or safeguarded with additional PSSD's that are not operating in PSDI.

10.10 Safeguarding maintenance personnel

Personnel that maintain robot systems shall be safeguarded from injury due to hazardous motion per 7.2 and be trained in accordance with clause 14.

NOTE – Tasks covered by this clause include routine servicing, minor tool change, correcting jams, troubleshooting failures, component repair and replacement.

10.10.1 Access to safeguarded space with no drive power available

When access to the robot or robot system is necessary, a procedure shall be followed that includes lockout/tagout of sources of power and releasing or blocking of potentially hazardous stored energy. When a lockout/tagout procedure is not used, alternate safeguards or safeguarding procedures shall be established and used to prevent injury.

10.10.2 Access to safeguarded space with drive power available

When entry into a safeguarded space is necessary while the drive power is available,

- a) a device for personal control by each entrant shall be installed and used to prevent robot motion and movement of other equipment, if such movement would present a hazard,
- or,
- b) personnel shall be protected by providing the clearance and safeguarding requirements in 10.8.5. In addition, safeguarding shall be added when the potential rear swing or side motion of robot components such as the shoulder, counterweight, drives or accessory structures create a pinch point to adjacent equipment.

NOTE – Exclusive control can be established by a variety of methods, such as through the locking of a control device that prohibits through hardware the initiation of motion in any cycle mode (i.e. manual, jog, etc.).

10.10.3 Entry procedures

Prior to entering the safeguarded space while drive power is on, the following procedures shall be performed:

- a) the robot system shall be visually inspected to determine if any conditions exist that are likely to cause malfunctions;
- b) if pendant controls are to be used, the enabling device shall be function tested prior to such use to ensure their proper operation;
- c) if any damage or malfunction of the safety system is found, corrections shall be completed and re-tested before personnel enter the safeguarded space.

10.10.4 Control of robot and robot system

Personnel performing maintenance tasks within the safeguarded space when drive power is available shall have total control of the robot or robot system. This shall be accomplished by the following:

- a) control of the robot shall be removed from the automatic mode;
- b) single point of control of the robot system shall be accomplished using a pendant consistent with 10.3;
- c) additional personnel within the safeguarded space shall comply with 10.10.2 or be furnished with and use an enabling device. Deactivation of the enabling device shall cause all hazardous motion in the safeguarded space to stop;
- d) all robot system emergency stop devices shall remain functional;

- e) to restore automatic operation the following shall be required:
 - 1) all personnel exit the safeguarded space;
 - 2) restore safeguards required for automatic operation;
 - 3) initiate deliberate start-up procedure.

10.10.5 Additional safeguarding methods

Additional safeguarding methods may be provided as follows:

- a) certain maintenance tasks can be performed without exposing personnel to trapping or pinching points by placing the robot arm in a predetermined position;
- b) the utilization of devices such as blocks/pins can prevent potentially hazardous motion of the robots and robot systems.

10.10.6 Alternate safeguards

If, during maintenance, it becomes necessary to disconnect or otherwise render inoperative any safeguards, alternative safeguarding shall be provided. Any inoperative safeguards shall be identified and shall be returned to their original effectiveness when the maintenance task is complete.

10.11 Safeguarding verification

Following the installation of safeguarding devices the system shall be tested and verified to ensure an adequate level of safety has been achieved. This review shall include, at a minimum, the following:

- a) all safeguarding devices must be tested under reasonably foreseeable conditions of use to ensure they are functioning as intended and protect personnel from hazards. Modifications must be made to correct deficiencies;
- b) the tasks must be reviewed to ensure that safeguarding does not inhibit task performance and encourage personnel to defeat the devices;
- c) safeguarding devices must be reviewed to ensure that they are not easily defeated or bypassed;
- d) determining if all tasks can be performed with the safeguarding devices in place. For those tasks that cannot be performed with safeguards in place alternative methods such as lockout must be used;
- e) determining under what circumstance it is necessary to be inside the safeguarded space with power on.

11 Safeguarding devices - application requirements

Safeguarding devices shall be designed, constructed, attached and maintained to ensure that personnel can not reach over, under, around, or through the device undetected and reach the hazard.

11.1 Barrier guards, fixed and interlocked

Barriers shall:

- a) prevent access to a hazard;
- b) be constructed to withstand operational and environmental forces;

- c) be free of sharp edges and projections and shall not themselves create a hazard;
- d) comply with table 5 for opening size and distance from hazard;
- e) require the use of tools to remove any fixed portion;
- f) be positioned so the bottom of the barrier is no more than 0.3 m (12 inches) above adjacent walking surfaces, that the top of the barrier be no lower than 1.5 m (60 inches) above adjacent walking surfaces unless additional safeguarding devices are installed to prevent or detect access to the hazard. The area between top and bottom shall be completely filled or comply with table 5;
- g) contain parts and tooling (e.g. loose objects, flying projectiles), where this possibility exists.

NOTE – Barriers installed around material handling robots need to be high enough to prevent any part from being thrown over the barrier. This precaution may not be necessary if the robot end-effectors are equipped with effective part retention hardware such as locking or over center closing clamps.

11.2 Barrier guards, interlocked

Interlocked barriers consist of a barrier and an interlocking means that allows the barrier to be opened.

11.2.1 Barrier portion

The barrier portion of the interlocked barrier shall be designed, installed, applied and maintained so that when used:

- a) it is in compliance with 11.1
- b) it is installed at a safe distance per table 6, but no closer than table 5 (barrier openings);
- c) it opens laterally or away from the hazard, and not into the **safeguarded space**, and cannot close by itself and activate the interlocking circuitry;
- d) it shall not be adversely affected by the environmental conditions;
- e) it is tamper resistant and cannot be defeated intentionally without tools;

11.2.2 Interlocking portion

- a) Each interlocking portion of the interlocked barrier shall be selected such that:
 - 1) it provides two sets of contacts for circuit integration per 10.4.6, unless a **risk assessment** is performed such that the use of a device with one set of contacts is determined to be acceptable (no retrofit is required for existing systems);

NOTE – A single safety switch with two sets of contacts or two separate switches that are integrated may comply with 4.5.4
 - 2) magnetic switches shall be magnetically coded to reduce the possibility of defeat or interference and allow automatic monitoring to detect faults with the sensor;
 - 3) it is not adversely affected by the environmental conditions of the application.
- b) The interlocking portion of the interlocked barrier shall be installed, applied, and maintained so that:
 - 1) switches designed with a positive opening operation (see 5.2.2b) shall be mounted in a positive mode, such that when the **actuator** is disengaged or moved, the motion forces a non-resilient linkage to open the normally closed (break) contact, which is used for the **safety stop** circuit (see figure B.6);

- 2) switches that are not positive opening/direct drive type shall be automatically monitored to detect faults with the switches or its installation (e.g. magnetic switches, limit switches, etc.);
- 3) the safeguarding device (e.g. safety switch) shall not be used as an end of travel stop;
- 4) the safeguarding device is tamper resistant and cannot be defeated without tools;
- 5) the hazard being guarded cannot be placed in **automatic operation** until the interlocked barrier is closed, and will issue a stop if the interlocked barrier is opened while the hazard is present;
- 6) closing the interlocked barrier shall not, by itself, restart automatic operation;
- 7) resuming automatic operation shall require a deliberate action outside the safeguarded space;
- 8) be capable of being easily unlocked from the inside of the safeguarded space with or without power available, when the possibility of full body access exists;
- 9) spare keys and actuating devices shall be supervisory controlled and not readily available.

NOTE – If spare keys and actuating devices are in demand for the purpose of defeating the safeguard, the design of the overall safety scheme should be reviewed for deficiencies.

11.3 Requirements for other safeguarding devices that signal a stop

Safeguarding devices which initiate a stop signal shall:

- a) be interfaced with the **robot** control system such that the detection of an intrusion shall cause stopping of the **hazardous motion**;

NOTE – This refers to installations that signal the hazard to cease.

- b) be installed and arranged per 10.4.3 so that persons cannot enter the hazardous area without the intrusion being detected, and cannot reach a hazard before the hazardous conditions have ceased;

NOTE – Safety distance may not be required per 10.4.3c when PSSD(s) are solely used to prevent start/restart or solely used for clearance safeguarding (ref 10.7.7 and 10.8.5.)

- c) not allow the restart of automatic operation by the removal of the intrusion without a deliberate action outside the safeguarded space, unless the device is functioning in a PSDI mode (10.9.2).
- d) provide for control over adjustments or settings being made by other than authorized personnel.
- e) have a readily observable indication that the device is functioning;

NOTE – Indicator lamps compliant with ANSI/NFPA 79 should be provided for all presence-sensing devices to indicate that the device is functioning. The lights may be integral to the device or part of the interface to the robot control.

Where color blindness is a consideration, unambiguous positioning, patterning, labeling, or flashing of the indicator may be an effective method of providing indication.

11.4 Safety light curtains/screens

Safety light curtains/screens shall:

- a) meet the requirements of 11.3;

- b) be installed at a safety distance that accounts for the increased object sensitivity, when blanking (fixed or floating) is used unless the opening is completely obstructed;
- c) visibly indicate the fixed blanked area, or the **user** shall verify that blanking is being used (or not used) as intended, including the number, size and location of the blanked beams;
- d) visibly indicate the number of floating beams or object sensitivity, otherwise the user shall verify that floating blanking is being used as intended.

NOTE – Fixed and Floating Blanking creates holes in the light curtain's coverage which are needed in some applications. If an obstruction does not fill the "holes", then the light curtain is installed at a greater safety distance due to the increased object sensitivity. Without visible indication of the blanked area or the number of floating beams enabled, the configuration may be changed with indication. If only one floating beam is allowed, a single specific floating beam indicator would indicate the number of floating beams. Although the changes would require access, it is desirable to verify that the installation integrity is as expected.

- e) be installed so reflective surfaces shall not cause the device to fail to respond to the presence of personnel.

11.5 Area scanning safeguarding devices

Area scanning **safeguard** devices shall:

- a) meet the requirements of 11.3;
- b) be installed for a safety distance and detecting plane height that accounts for the detection zone's maximum object sensitivity and also includes the device's total range measurement tolerance in the safety distance calculation, see 10.4.3

NOTE – Object sensitivities greater than 70 mm may not detect ankles, so the height above floor is an important installation consideration.

- c) have a visibly identifiable detection area;
- d) be tested to ensure that the device is able to detect all objects and personnel entering the detection area;

NOTE – For example, dark clothing may be detected only with devices having specific diffused reflectance detection capabilities. These devices operate on a principle of transmitting beams(s) of light to form a detection zone. When an object enters the detection zone, it reflects the transmitted light back to the device, which then evaluates the object's position. The amount of reflected light (degree of reflectance in percent) which can be reliably detected typically ranges from 1.8% to over 90%.

- e) have the detection area verified upon installation, replacement, or changes within the detection area for proper size and coverage before the device will allow the hazardous motion to start or restart.

NOTE – This verification can be accomplished manually by using a programming device, by verifying the marked or intended detection area, or using an operation mode commonly called "test-on-startup", which may require an intrusion into the detection area before the device can be reset. This verification can also be accomplished automatically if the control system can identify that the device has not been moved, relocated, or replaced.

11.6 Radio frequency (RF)/capacitance safeguarding devices

RF/capacitance safeguarding devices shall:

- a) meet the requirements of 11.3;

- b) have their sensitivity properly set;
- c) be verified, by the user, for proper sensitivity adjustment setting on a routine basis.

11.7 Safety mat systems

Safety mat systems shall:

- a) meet the requirements of 11.3;
- b) be of sufficient size and geometry to detect intrusion from all places of access;
NOTE – See annex B for examples.
- c) be securely mounted such that it cannot be inadvertently moved or removed;
NOTE – Means to prevent inadvertent movement may be but are not limited to: Secured edging, secured trim, fasteners, recessed, size and weight of large mats.
- d) be installed to minimize tripping hazards;
NOTE – Ramped edging is often used to securely mount a safety mat and also helps to minimize tripping hazards. When installing a safety mat with a unidirectional surface pattern, consideration should be given to ensure that the safety mat is installed such that the surface pattern would reduce slipping towards the hazard.
- e) not exceed minimum object sensitivity per 5.3.4(b) where multiple mats are installed together to form a single sensing surface;
- f) have a maximum response time which is less than 100 ms over the system operating temperature range;
NOTE – A total mat system response time of greater than 100 ms may allow a person to step lightly and quickly over the mat's sensing surface without being detected.
- g) have a construction suitable for the application and environment;
- h) be routinely inspected, and function tested per manufacturers recommendations;
- i) be installed and arranged such that reset of the safety function requires removal of the obstruction from the sensing surface followed by a separate and deliberate action outside of the sensing surface, when used as the sole means of **safeguarding**;
- j) be installed at a safety distance such that the edge of the safety mat sensing surface which is furthest from the hazard is at or beyond the safety distance from the hazard, unless the safety mat is being used solely to prevent start/restart of automatic operation or for pinch point protection where clearance requirements per 10.7.7 and 10.8.5 are not met.
- k) the system (mat, controller, wiring between mat and controller) shall comply with 5.3a

11.8 Single and multiple beam safety systems

Single and multiple beam safety systems shall:

- a) meet the requirements of 11.3;
- b) be installed so reflective surfaces shall not cause the device to fail to respond to the presence of personnel;
- c) not be used for finger or hand detection in a point-of-operation installation.
NOTE – See illustrations in Figure B.2

11.9 Two hand control systems

Two hand control systems when used as the primary means of personnel safeguarding shall:

- a) be designed to prevent accidental or unintentional operation;
- b) have the individual **operator's** hand controls arranged by design, construction, or separation to require the use of both hands within 500 ms to initiate/**cycle** the **robot system**;
- c) require individual hand controls for each operator when multiple operators are safeguarded by two hand controls;
- d) require each operator two hand control station to be concurrently operated before initiation to cycle the robot system, and be maintained during the hazardous portion of the cycle and signal a stop if one or both hands are removed from the controls when the two hand control system is the only means of safeguarding;
- e) require supervisory personnel to deselect operator two hand controls when more than one operator control is provided;
- f) prevent cycling of the robot system if all operator stations are deselected;
- g) be designed to require the release of all selected operator's hand controls and the re-activation of all operator's hand controls before a robot system cycle can be initiated;
- h) have all operator's hand controls located in clear view of the hazard for which the operator hand control is being used;
- i) have all operator's hand controls located such that the person operating the controls is located at a safe distance per table 6;
- j) provide other safeguarding means for personnel other than those using the two hand controls.

NOTE – Two hand controls only provide protection for the personnel using them.

12 Maintenance of robots and robot systems

The **user** of a **robot/robot system** shall establish a maintenance program as required for the continued safe operation of the robot/robot system. The user should be able to demonstrate that an effective inspection and maintenance program is in place. The inspection and maintenance program shall consider the recommendations of the manufacturer of the robot or the robot system and local application specific requirements.

13 Testing and start-up of robots and robot systems

The following procedures shall be followed during the start-up (including initial start-up) and testing of **robots** and **robot systems** after installation or relocation. These procedures apply to robots/robot systems after software/hardware changes and after maintenance that could affect their safe operation.

NOTE – This applies only to the robot operating system, not user programs or normal daily or shift start-up procedures.

13.1 Interim safeguarding

All robots and robot systems require the installation of **safeguarding devices** per 7.1. If the designed **safeguard** devices are not yet available or in place prior to initiating a start-up and testing procedure, an appropriate means of **safeguarding** shall be in place before proceeding.

NOTE – During the initial assembly of a robot cell, all the final safeguards may not be installed. Therefore, alternative safeguarding such as chains or portable walls should

be put in place to provide effective protection for personnel during the initial startup of the robotic equipment.

Factors to consider in selecting the alternative safeguards may include: Training level of personnel involved, time period of this interim situation, accessibility of this cell to other personnel, the type of equipment operating, how much equipment is operating at a given time, and hazards presented by this equipment.

As a minimum, awareness barriers shall be installed to define the restricted space.

13.1.1 Selection of interim safeguards

Interim **safeguards** shall provide personnel protection against the same **hazards** as originally identified under 7.1.

The safeguards may be:

- a) the same, but installed differently;
- b) different devices used in optional applications;
- c) temporary in nature;
- d) substitute written procedures;
- e) awareness means
- f) specific training

All interim safeguards shall be identified, documented, and explained to all affected personnel.

13.2 Manufacturer/integrators' instructions

The manufacturer/integrators' instructions for start-up and testing of the robot and/or robot system shall be followed.

13.3 Initial start-up procedure

At each stage of implementation (7.3) an initial start-up procedure shall include, but not necessarily be limited to, the following:

- a) Before applying power, verify that the following have been installed as intended:
 - 1) mechanical mounting and stability;
 - 2) electrical connections;
 - 3) utility connections;
 - 4) communications connections;
 - 5) peripheral equipment and systems;
 - 6) **limiting devices** for restricting the **maximum space**.
- b) All personnel shall exit the **restricted space** prior to applying **drive power**.
- c) After applying power, verify:
 - 1) **Emergency stop** circuit/devices are functional;
 - 2) Each axis moves and is restricted as intended;
 - 3) robot responds to basic operating system motion commands as expected;
 - 4) all safeguarding devices or interim safeguards function;
 - 5) **slow speed control** (4.9).

13.4 Personnel protection

No personnel shall be allowed in the restricted space during the initial start-up and testing of the robot and/or robot system.

NOTE – This is especially critical during initial power-on to ensure that the robot and equipment move/operate in the expected manner.

14 Safety training of personnel

The **user** shall ensure that any person who **programs**, teaches, operates, or maintains **robots** or **robot systems** or associated equipment in a robot cell is trained on safety issues related to assigned tasks.

NOTE – This training is best presented when integrated with operational training.

14.1 Training objectives

The objective of a training program is to provide information on:

- a) the purpose of safety devices and their function;
- b) procedures, specifically those dealing with health and safety;
- c) **hazards** presented by and capabilities of the robot or robot system;
- d) tasks associated with a specific robot and application;
- e) safety concepts.

14.2 Training requirements

Training may be accomplished through classroom training, on the job training, or a combination of both. Training documentation will include at a minimum a description of the training, attendees, and date conducted. See annex D for sample course design and documentation.

Training shall include:

- a) industry standards and instructions designed for the protection of personnel;
- b) the robot vendor safety recommendations;
- c) procedures that contain steps related to safety actions;
- d) lockout and tagout procedures;
- e) emergency procedures;
- f) general work place safety procedures

and the following specific training program content based on assigned tasks.

14.2.1 Safeguard training

Training on **safeguarding devices** shall include, but not be limited to:

- a) types of safeguarding devices;
- b) capabilities/options of safeguarding devices;
- c) description of devices selected for a specific application;
- d) function of the selected devices;

- e) functional test of the device;
- f) limitations of the selected device.

14.2.2 Training the teacher

Training the **teacher** shall include, but not be limited to:

- a) **slow speed control**;
- b) **safeguards** which are bypassed during **teach**;
- c) **pendant** operation;
- d) **single point of control**;
- e) process safety/control;
- f) response to abnormal/unexpected events;
- g) hazards during teach;
 - 1) pinch point locations
 - 2) observation points
 - 3) robot motion at slow versus program speed
 - 4) robot performance in teach
 - 5) **singularity**
 - 6) slow speed playback;
- h) auxiliary equipment.

14.2.3 Training the operator

Training of the **operator** shall include, but not be limited to:

- a) robot tasks;
- b) hazards related to each task;
- c) response to abnormal/unexpected events;
- d) recovery of operation;
- e) auxiliary equipment.

14.2.4 Training the APV operator

If the capability is provided, training the operator about APV shall include, but not be limited to:

- a) All items in 14.2.2 "Training the teacher;"
- b) hazards involved with:
 - 1) high speed
 - 2) observations points
 - 3) process materials
 - 4) failure modes
 - 5) alternative safeguards

- 6) path geometry
- 7) singularity;
- c) safe path of retreat;
- d) emergency procedures;
- e) special operator requirements and procedures for APV described in 10.8.4.

14.2.5 Training maintenance personnel

Training maintenance personnel shall include, but not be limited to:

- a) applicable tasks in 14.2.2 through 14.2.4 relating to training the teacher and operator;
- b) hazards involving:
 - 1) preventive maintenance/calibrations
 - 2) troubleshooting
 - 3) repair
 - 4) operational checks
 - 5) singularity
 - 6) failed safety devices
 - 7) failed communication systems
 - 8) process variables
 - 9) process materials;
- c) emergency operations;
- d) hazards involved in procedures on live robots versus robots disabled by lockout/tagout;
- e) hazards involving auxiliary equipment.

14.3 Retraining requirements

Retraining shall be provided to include system changes and assure safe operation.

NOTE – These changes may include, but are not limited to:

- a) personnel changes
- b) system changes
- c) after an accident.

Annex A
(Informative)

Graphical aids to understanding the standard

Application	Clause	Effective Date
General provisions of standard	1.3	On or before June 21, 2001
New and remanufactured robots	1.3.1	On or before June 21, 2001
Rebuilt and redeployed robots	1.3.2	Must comply with standard in effect on date of manufacture
New robot systems and workcells	1.3.3	On or before June 21, 2002
Existing robot systems and workcells	1.3.4	Must comply with standard in effect on date of installation and specific criteria in 1.3.4. Any retrofit to be done by June 21, 2001

NOTE – Existing systems include all systems installed prior to the effective date.

Attended Continuous Operation (ref ANSI/RIA R15.06-1992 §6.7) has been eliminated and is not allowed.

Table A.1 – Effective dates by clause for this standard

Most Effective	1) Elimination or Substitution	<ul style="list-style-type: none"> • eliminate human interaction in the process • eliminate pinch points (increase clearance) • automated material handling
↓	2) Engineering Controls (Safeguarding Technology)	<ul style="list-style-type: none"> • mechanical hard stops • barriers • interlocks • presence sensing devices • two hand controls
↓	3) Awareness Means	<ul style="list-style-type: none"> • lights, beacons and strobes • computer warnings • signs • restricted space painted on floor • beepers • horns • labels
↓	4) Training and Procedures (Administrative Controls)	<ul style="list-style-type: none"> • safe job procedures • safety equipment inspections • training • lockout
↓	5) Personal Protective Equipment	<ul style="list-style-type: none"> • safety glasses • ear plugs • face shields • gloves
Least Effective		

Table A.2 – Hierarchy of safeguarding controls

□ Maximum space

▨ Restricted space

■ Operating space

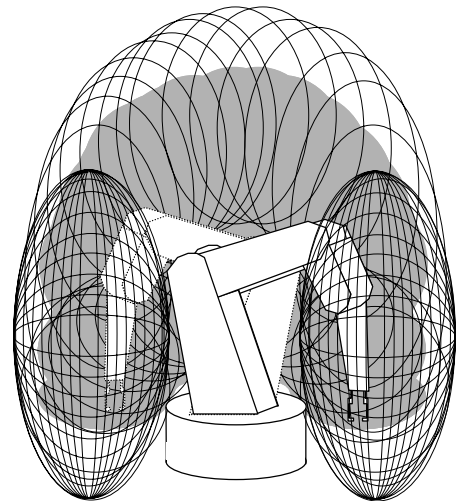
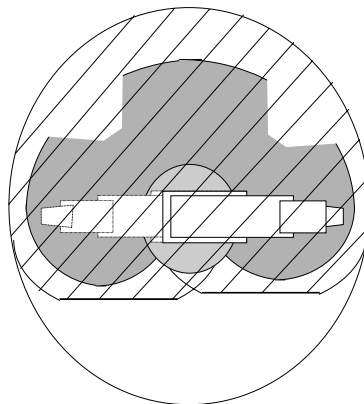
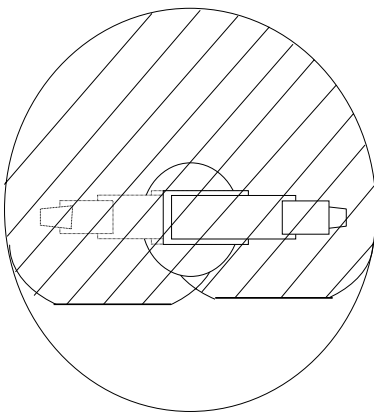
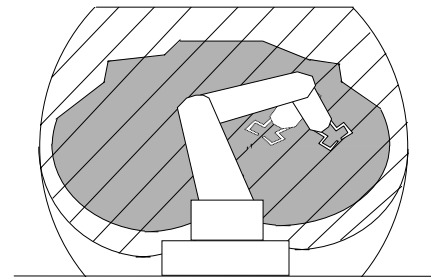
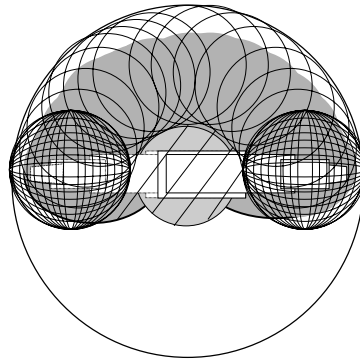
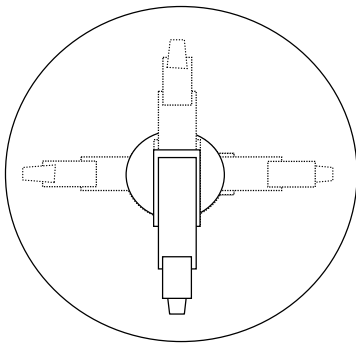
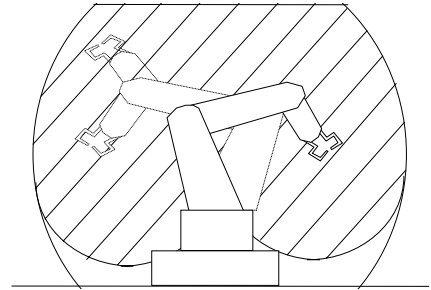
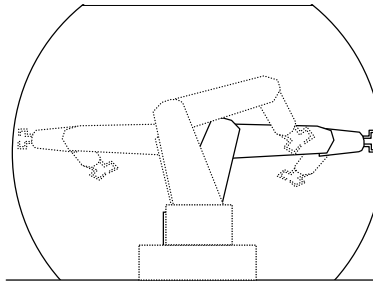
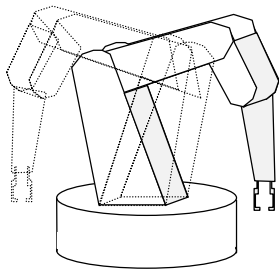

Figure A.1 - Space requirement illustrations

(continued)

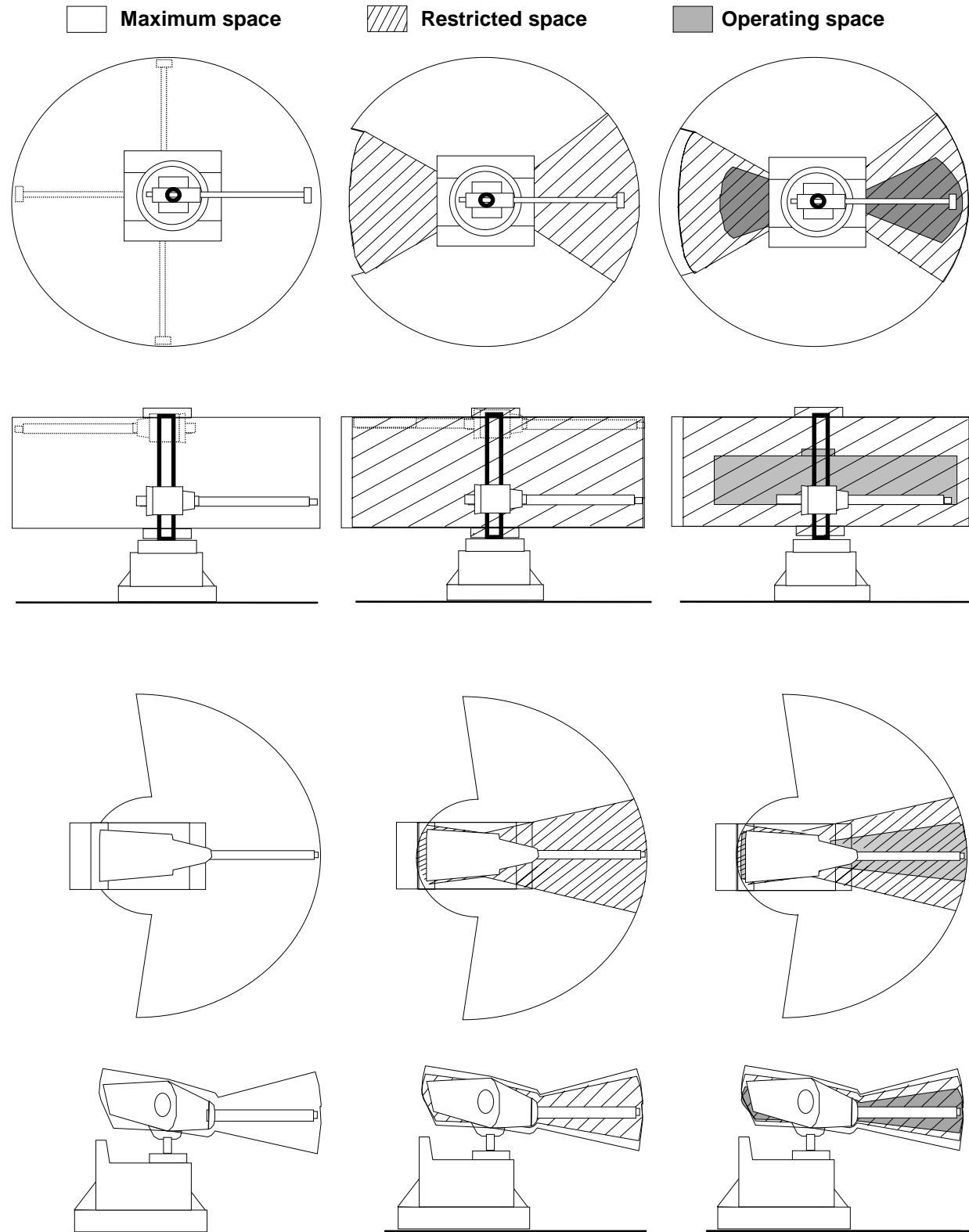

Figure A.1 – Space requirement illustrations (continued)

 **Restricted space**

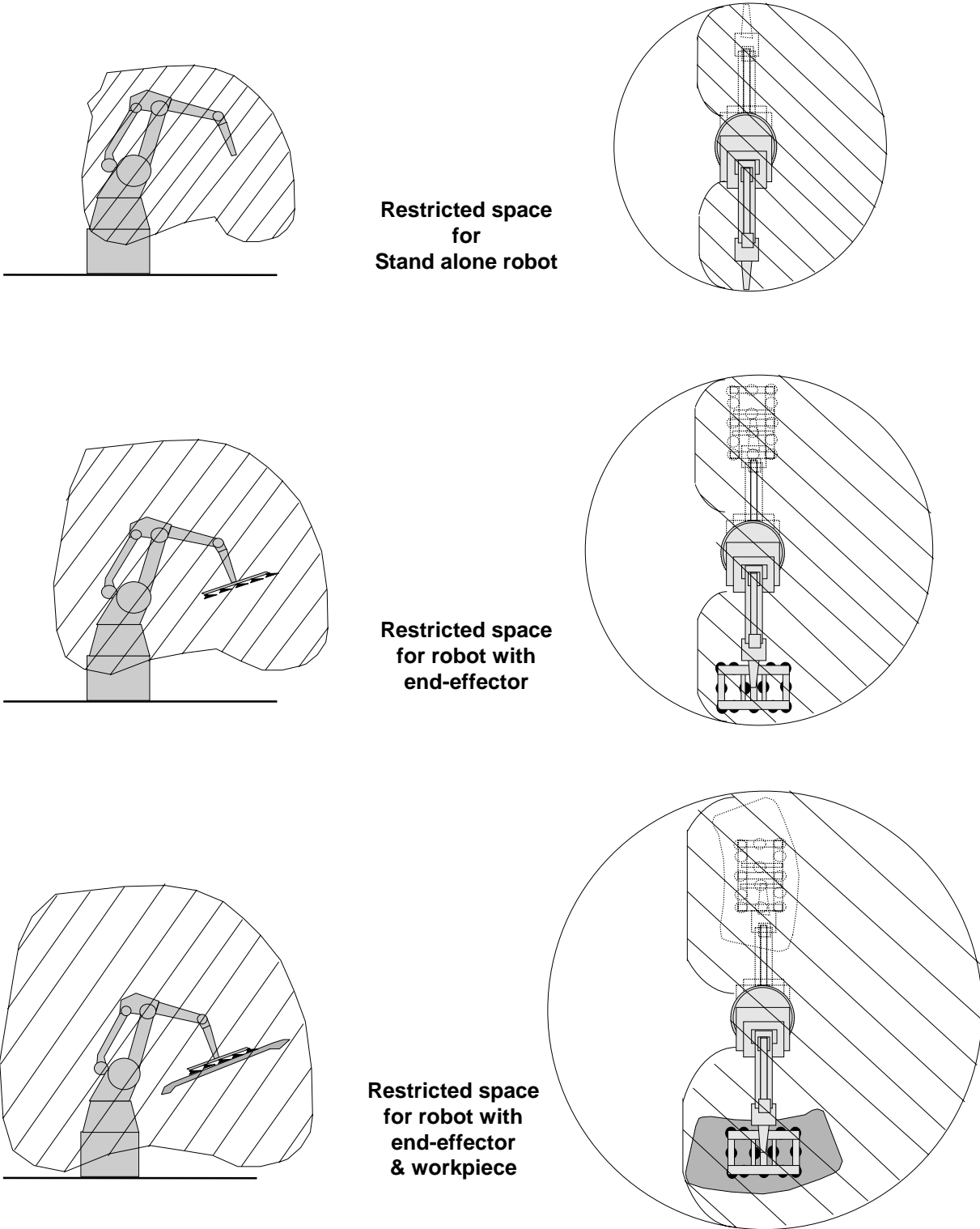
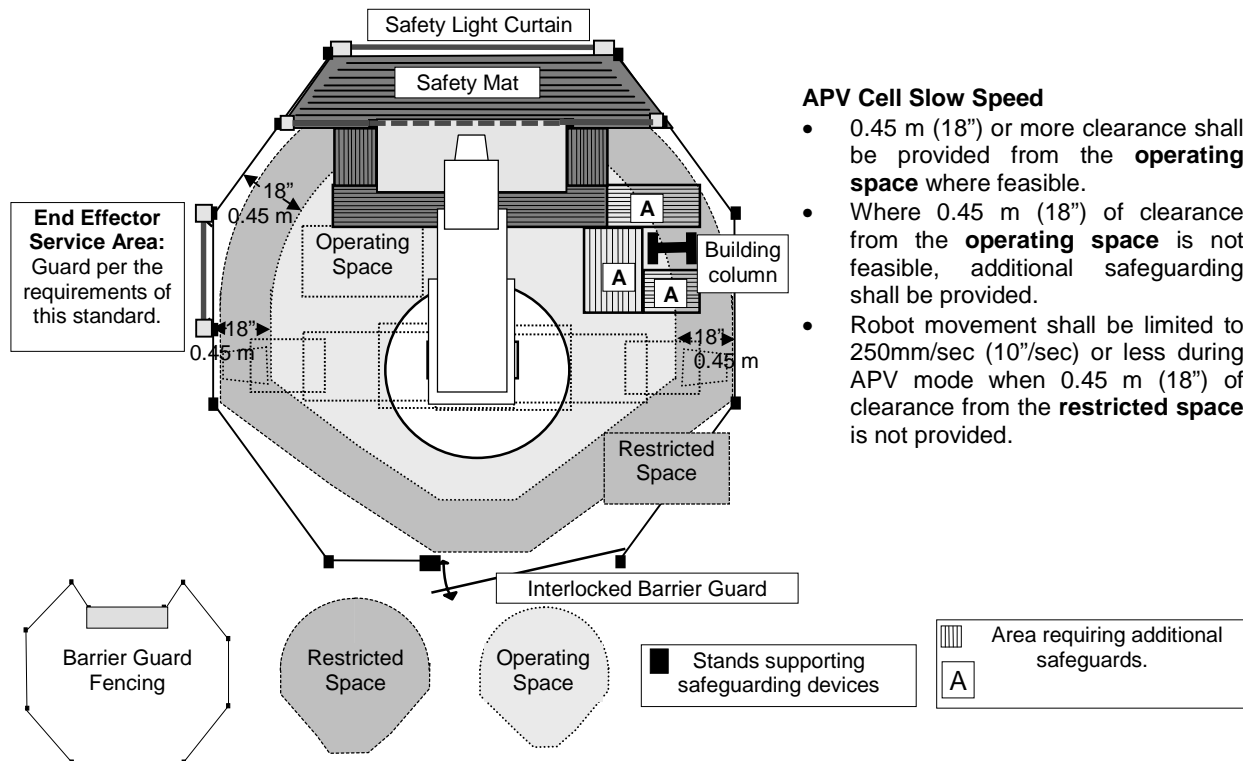

Figure A.1 – Space requirement illustrations (concluded)

APV Cell requirements: Slow Speed APV (250 mm/sec or less) Reference 10.7.7



APV Cell requirements: High Speed APV Reference 10.8.5

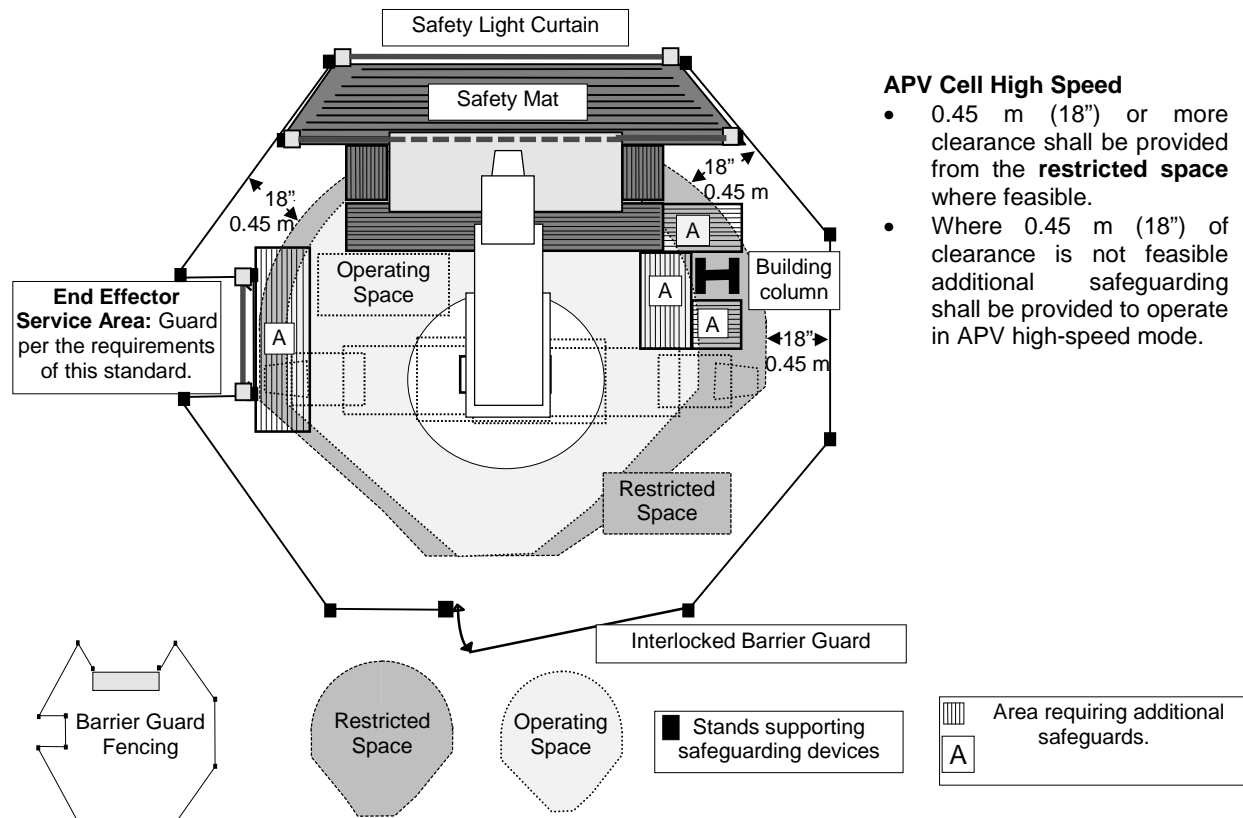
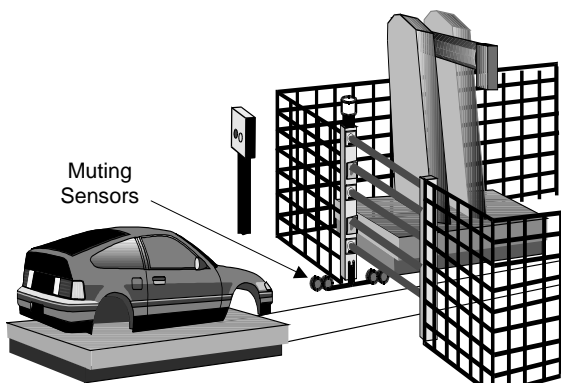
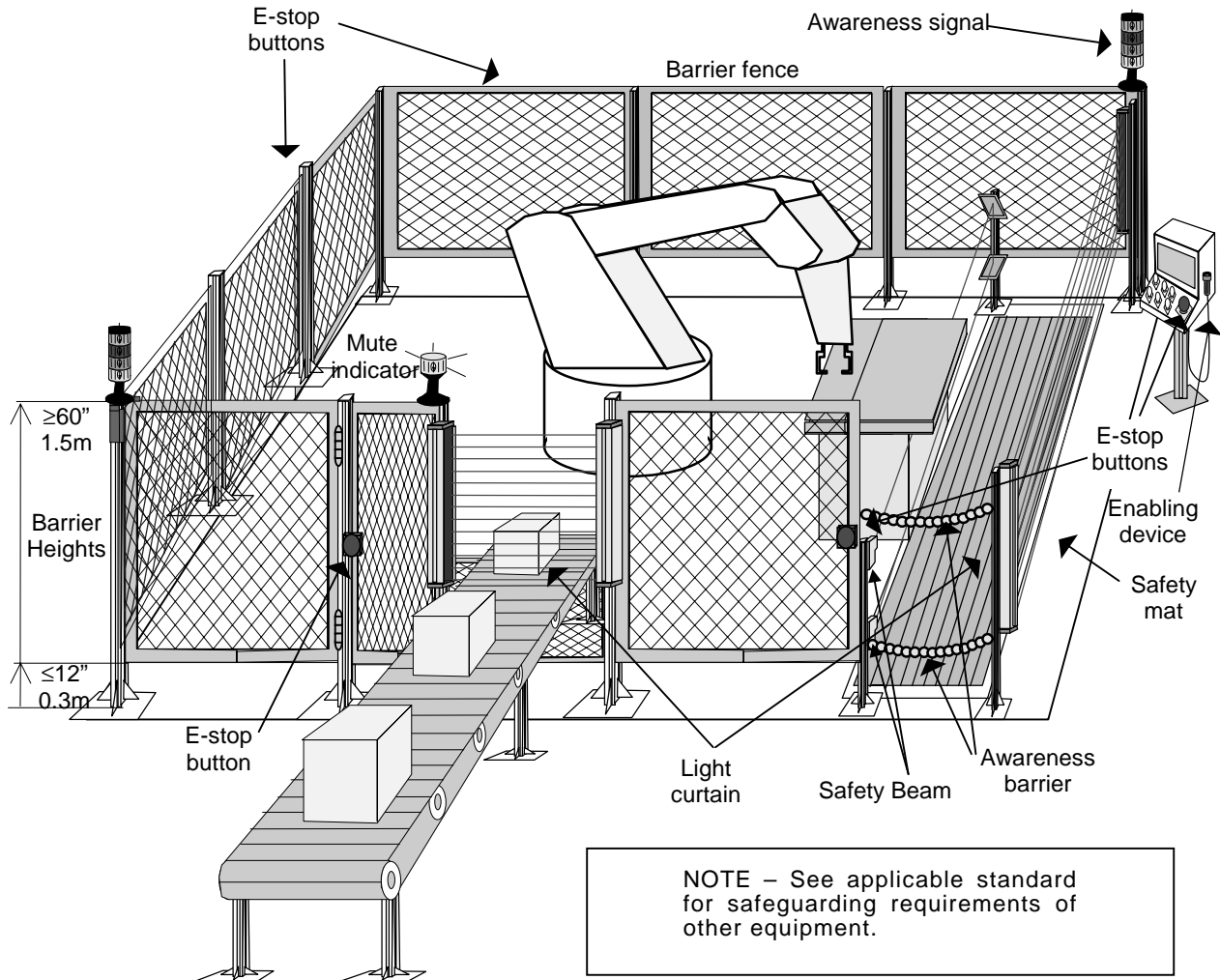
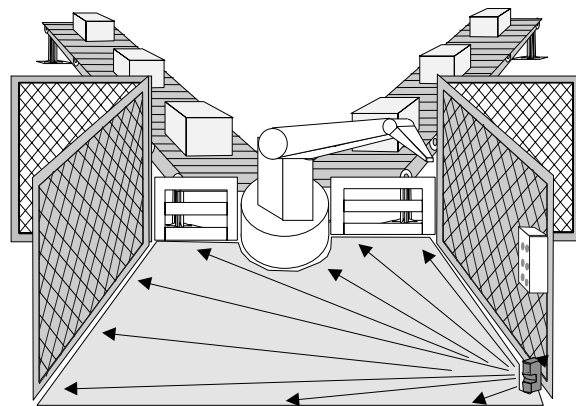

Figure A.2 – Clearance requirements



Entry / Exit safeguarding with uni or bi directional muting. Note: It should not be possible for person(s) to enter area while muting is active. Muting sensors, timing functions, and muting indicator lamp is monitored by the safety system. All light curtain beams are not necessarily muted.



Access area safeguarding with Proximity safety scanner. Area safeguarding devices should also be used to monitor areas not visible from the point of reset.

Figure A.3 – Typical workcell illustrations

Annex B
(Informative)
Safeguarding device supplemental information

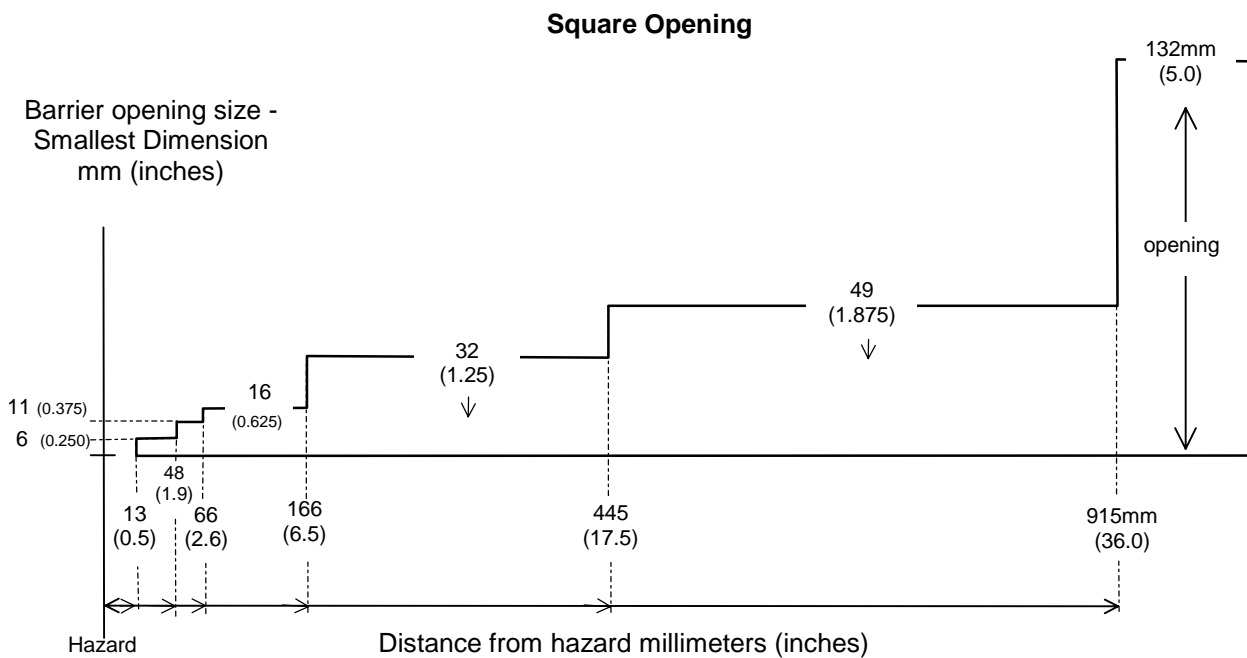
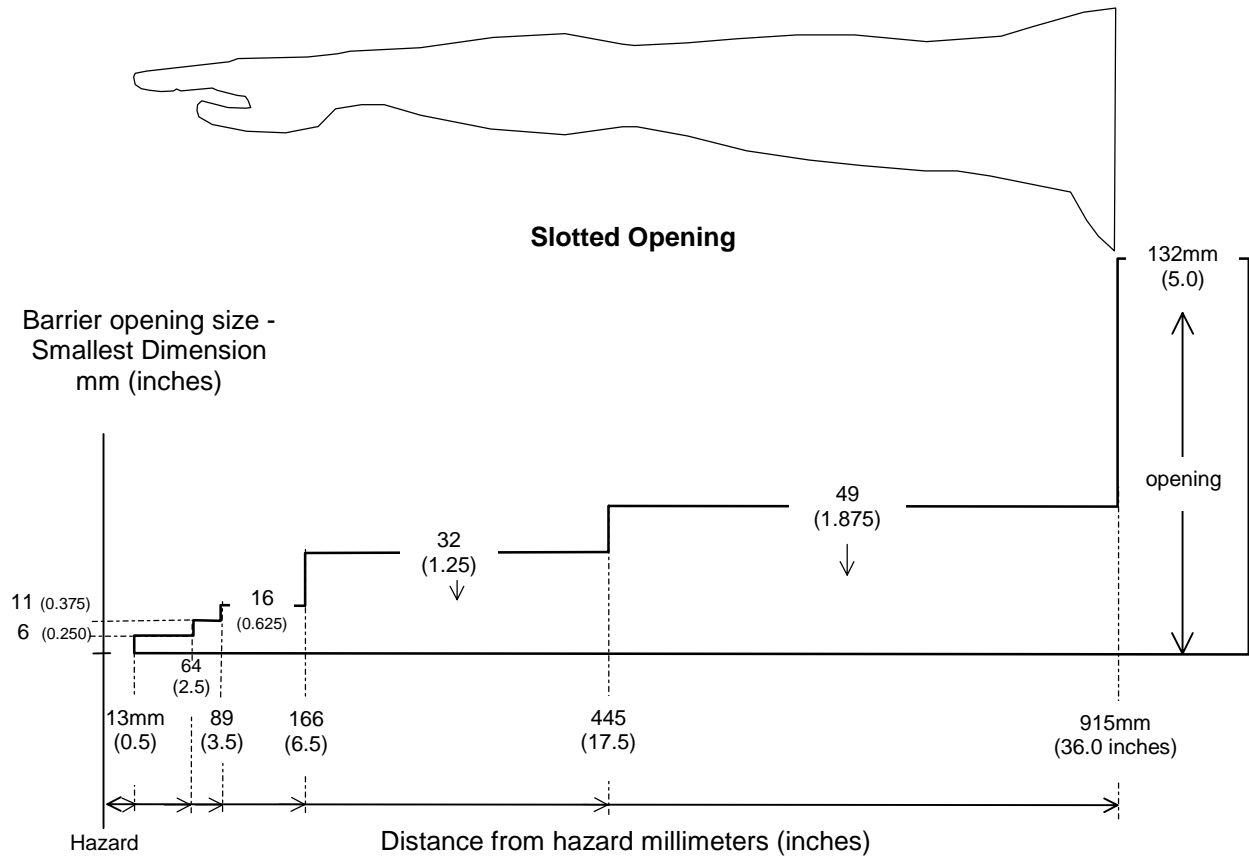

Figure B.1 – Graphical illustration of Table 5, barrier distance

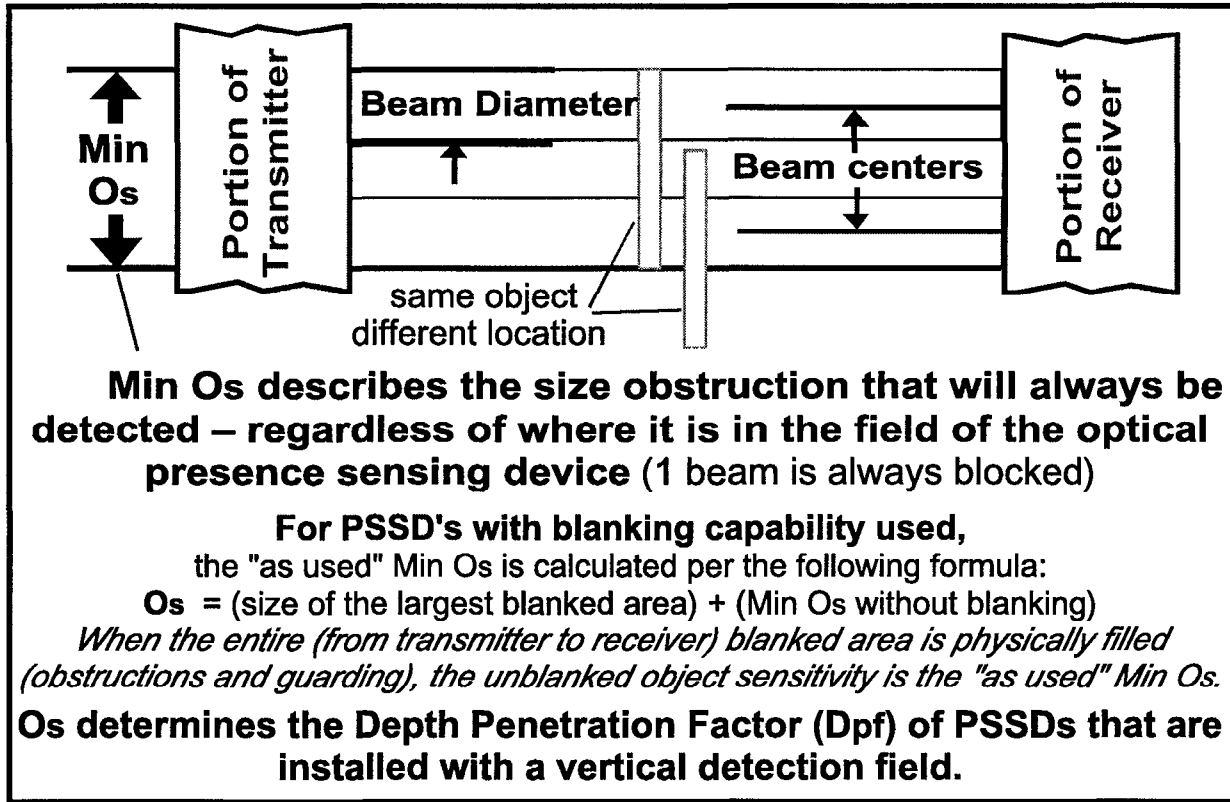

Figure B.2a: Optical PSSD Minimum Object Sensitivity

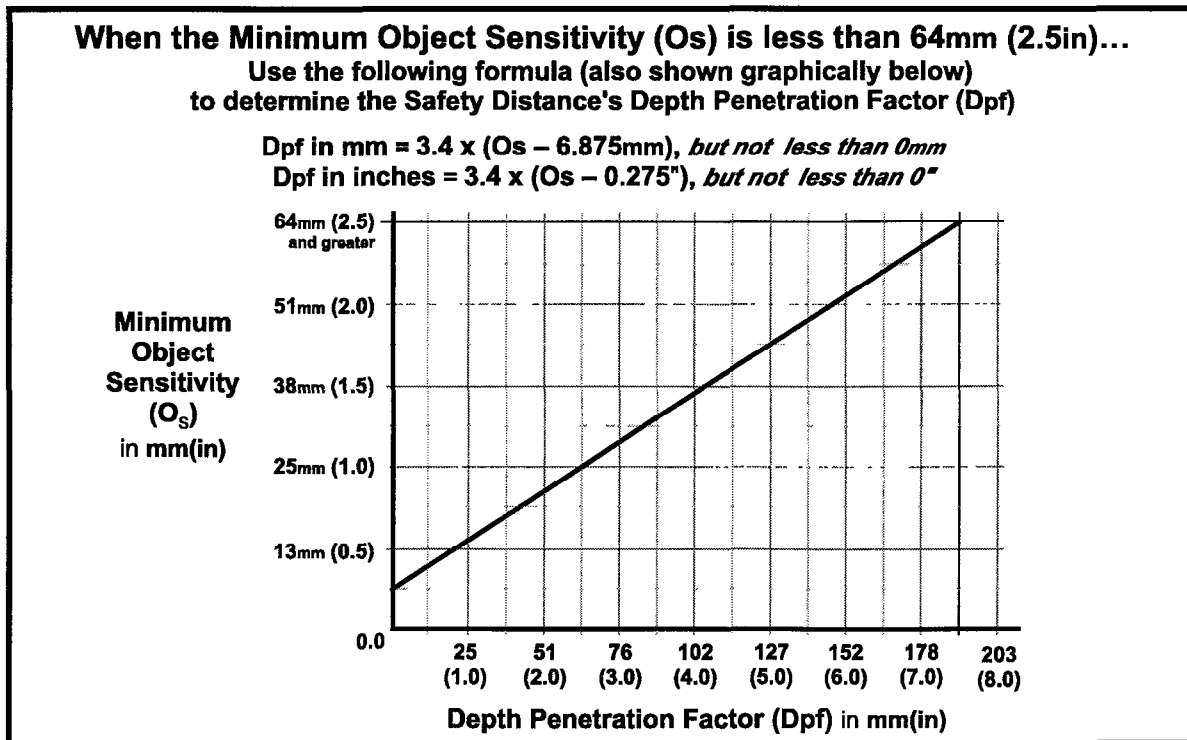

Figure B.2b: Optical PSSD Minimum Object Sensitivity and Depth Penetration Factor

Figure B.2 – Safety Distance Examples

(Continued)

Optical PSSDs - Vertical Field

Although light curtains shown, below applicable to all optical PSSDs (single beams and scanners)

Dpf Determined by Os and Installation

Assumes there are no other safeguards and no physical obstructions limiting access to the hazard

"REACH THRU"	"REACH OVER"
1st beam at 0.3m (12") max	1st beam at 0.3m (12") max
Top beam at 1.2m (48") min	Top beam at 0.9m (36") min

Object sensitivity (Os) is less than 64mm (2.5")
 $Dpf = 3.4 \times (Os - 6.875 \text{ mm})$
 $Dpf = 3.4 \times (Os - 0.275")$
but not less than 0 **Dpf = 1.2m (48")**

Os is equal or greater than 64mm (2.5") AND does not exceed 0.6m (24")
Dpf = 0.9m (36") **Dpf = 1.2m (48")**

Figure B.2c

PSSD Depth Penetration Factor (Dpf)

Horizontal Detection Field

When PSSD is used to signal a stop
Dpf = 1.2m (48")

Assumes there are no other safeguards and no physical obstructions limiting access to the hazard

Depth of Field = Dpf,
 Depth of Detection *depth of mat, length of light curtain, scanner coverage*
 but Depth of Field is not to be less than 0.9m (36")

If physical obstructions exist, Depth of Field may be reduced to 0.9m (36"), even though the Dpf remains 1.2m (48").

Safety Mat on a platform

Light Curtain or Scanner

* NOTE: With optical PSSDs mounted horizontally, supplemental safeguarding may be needed if $H \geq 0.3m (12")$ and there are no physical obstructions limiting access to the hazard. See Figure B.2i about Os & H

H is the height above the adjacent walking surface

Install horizontal sensing PSSDs such that personnel can not lean or leverage themselves such that their presence is not sensed by the PSSD.

Figure B.2d

Operator Interface / Point of Operation Safeguarding

For operator interface / point of operation safeguarding, complete coverage is required: NO gaps in coverage & no undetected walk through. Installed so the hazard ceases before it can be accessed by personnel AND if PSSDs are used to signal the hazard to cease, presence is continuously sensed to prevent restart.

Instead of a light curtain, a safety mat or area scanner may be used for walk-thru detection

0.3m (12") max

Dpf

Ds (safety distance)

Due to space constraints, Ds and Dpf are not like-sized for these graphics.

Dpf

Ds

30° shown

If angle is $\geq 30^\circ$, Dpf is same as vertical PSSD field.
 If less than 30° , horizontal field requirements apply.

Figure B.2e

Figure B.2 – Safety Distance Examples (Continued)

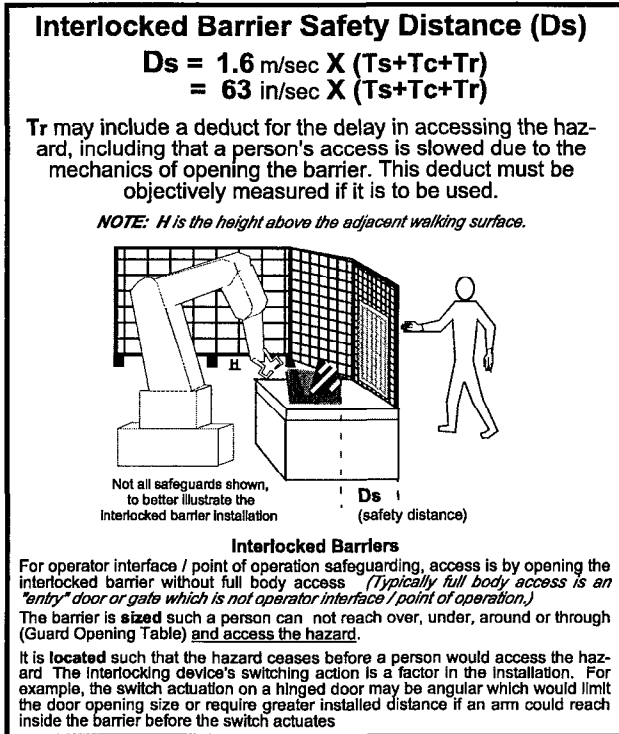

Figure B.2f

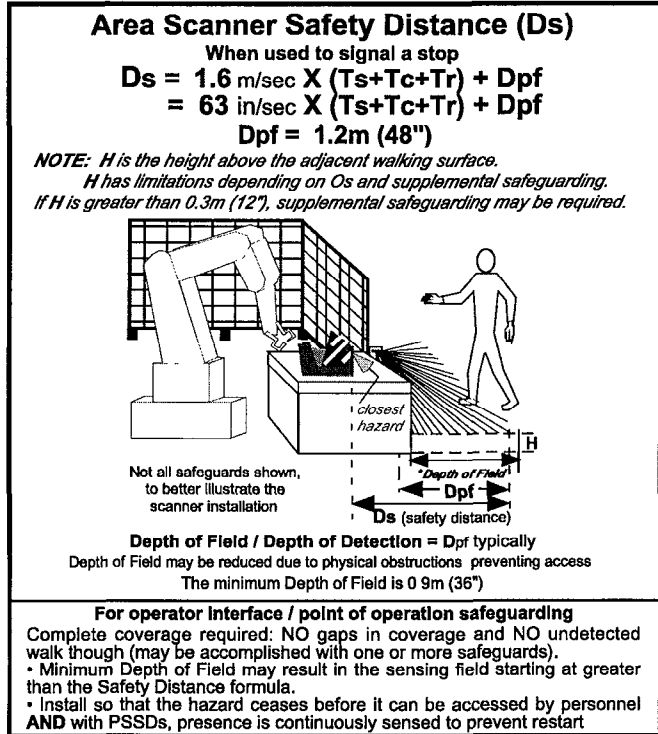

Figure B.2g

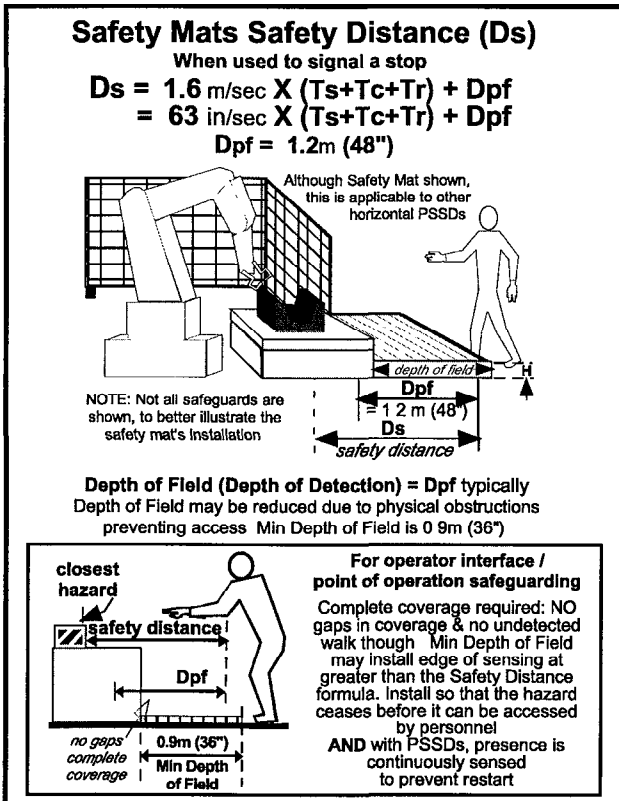

Figure B.2h

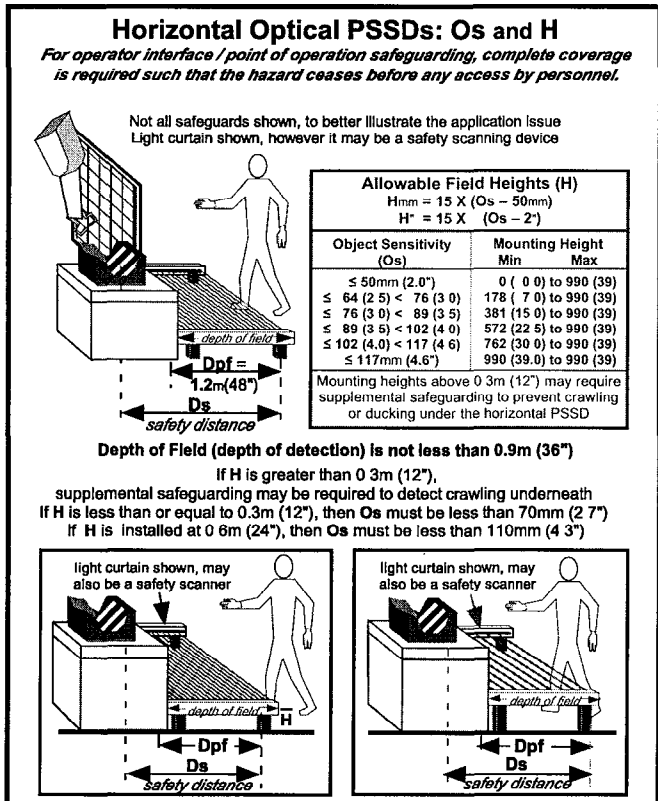

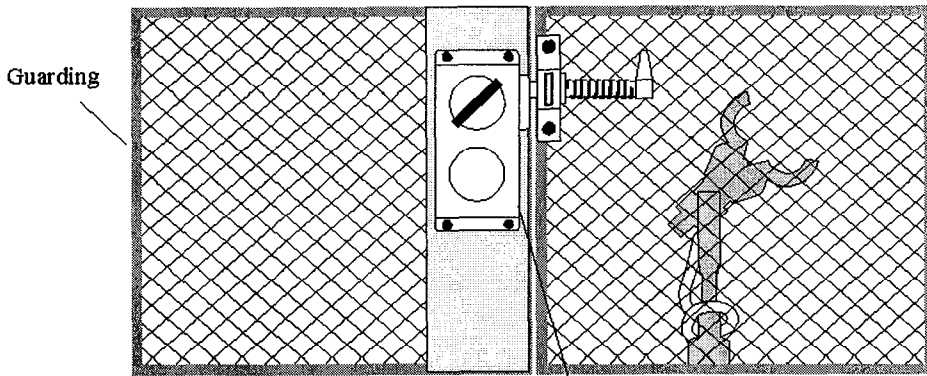

Figure B.2i

Figure B.2 – Safety Distance Examples (Concluded)

Gate Locked Closed - Power On

-  Key Free
-  Key Trapped



Access Lock

The access lock is a two part mechanical device, and can only be opened using the key from the lock on the circuit breaker.

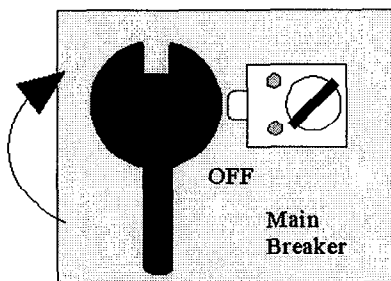

Mechanical Bolt Lock

The mechanical bolt lock is mechanically linked with the main circuit breaker, such that the key cannot be released while the breaker is "on".

Gate Open - Power Off

-  Key Free
-  Key Trapped

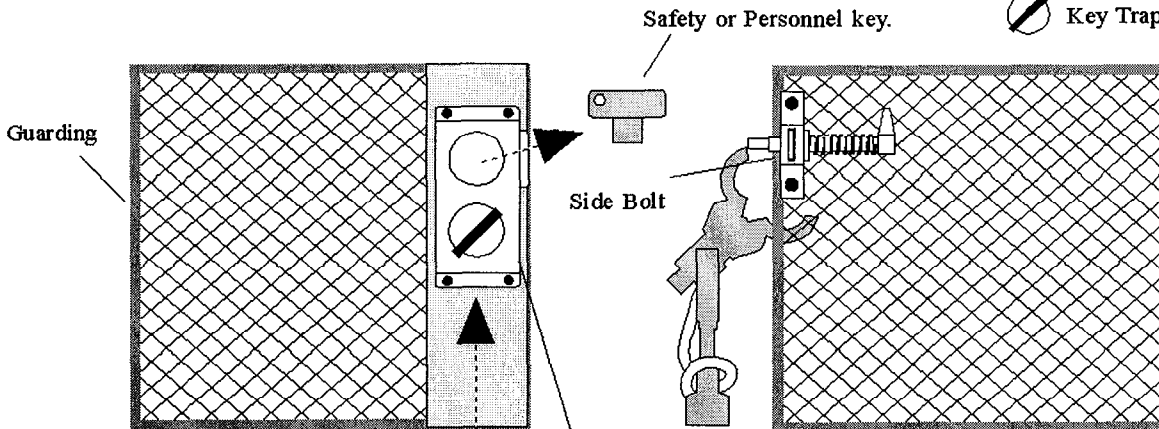

Access Lock

The key from the mechanical bolt lock is inserted into the bottom portion of the access lock. This allows the top key to be turned and removed. (Trapping the bottom key.) When the top key has been removed the side bolt can be removed and the gate opened. The top key is taken into the safeguarding space, ensuring power cannot be restored.

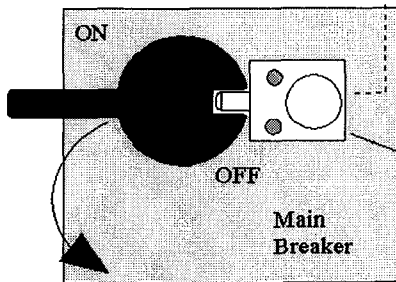

Mechanical Bolt Lock

When the key is turned and removed, the bolt extends and locks the cam in place. (The "off" position.) The breaker cannot be turned "on" without the key in place.

Figure B.3 - Example trapped key interlocking system

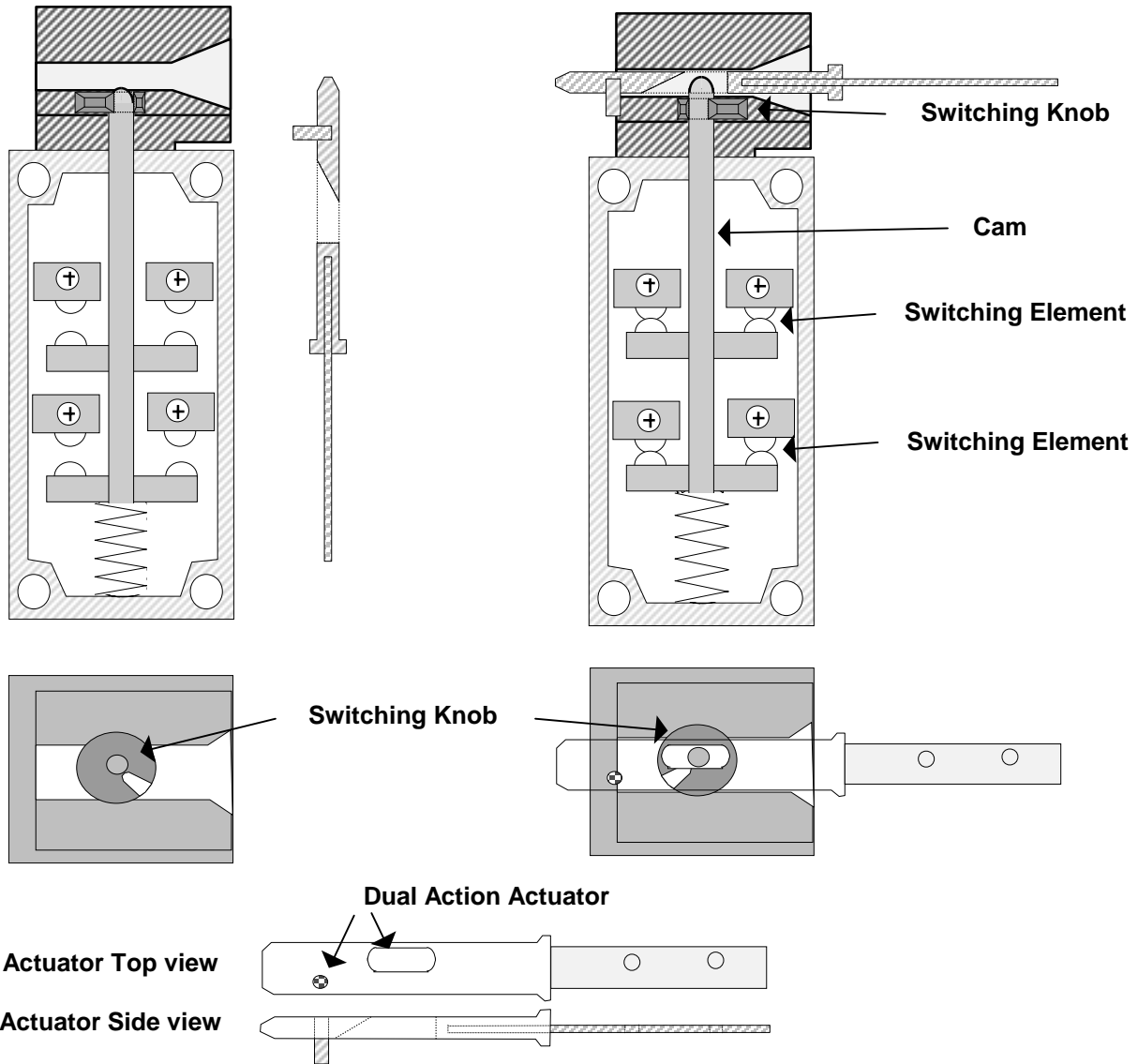

Safety interlock switches: the positively opening switching element directly driven by a cam. The cam and the switching element are structurally connected, forming one functional unit in the switching process. An actuator (key) operates the switch through a positive interlocking switching mechanism at the switching knob. Dual action design is preferred for tamper resistance purposes and required for operation.

Figure B.4 – Safety Interlock Switches

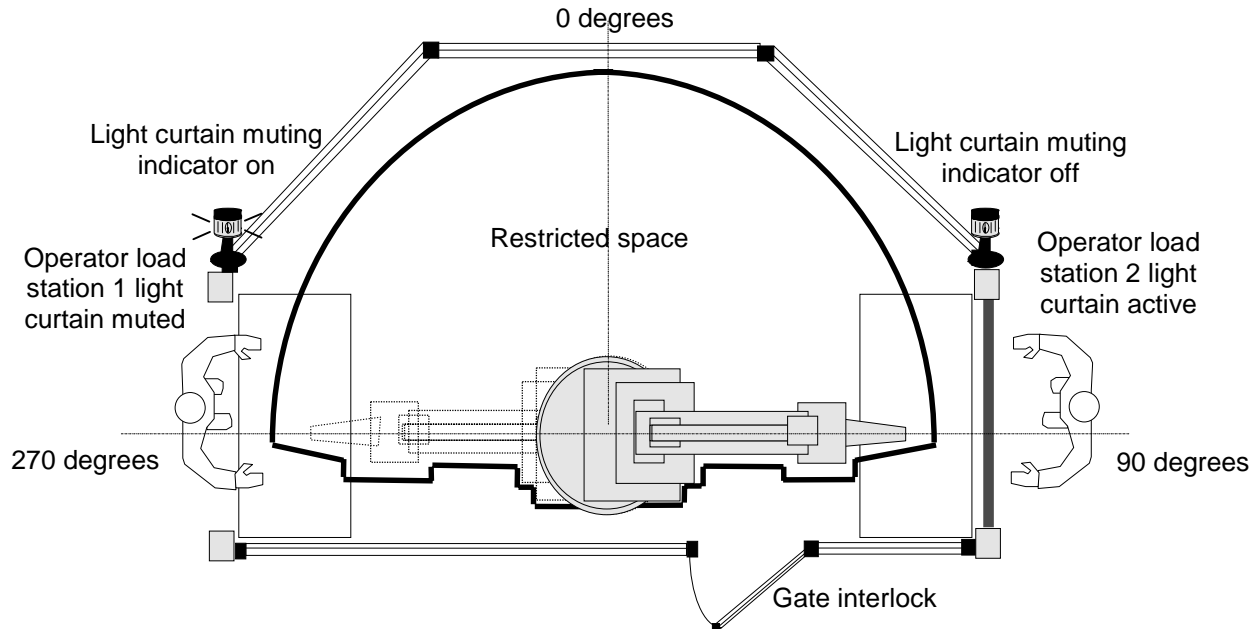

Mechanical hard stops prevent robot operation between 90 and 270 degrees, and allow operation between 270 and 90 degrees. Base limit switches are configured to operate in a diverse redundant complimentary fashion and are monitored for timing and proper operation. The robot control will allow motion into adjacent operator station only if the light curtain in that station is clear. Additional base limit sensors are normally utilized to enhance muting performance when the robot is at a safe distance from the operator stations. Gate interlock is always active in automatic mode (never muted). Muting devices, indicators, and circuitry are monitored by the muting control for proper operation cyclically or when change of status occurs or should occur. NOTE: Muting devices are not necessarily mechanical switches.

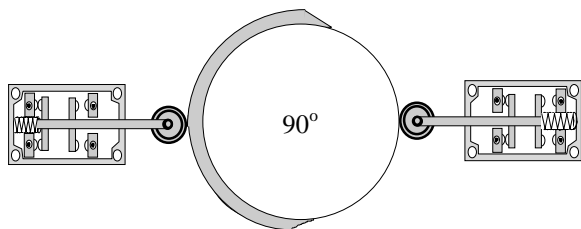

Base muting limit switches with robot at 90 degrees: both of the closed sets of contacts shown on the left must be closed in order to mute light curtain at operator load station 1.

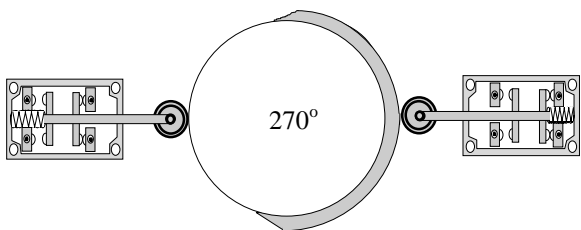

Base muting limit switches with robot at 270 degrees: both of the closed sets of contacts shown on the left must be closed in order to mute light curtain at operator load station 2.

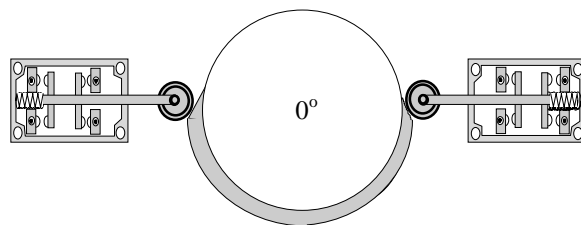

Base muting limit switches with robot at 0 degrees: Transition period will require both light curtains to be clear for robot motion to occur with this design. Transition period will be dependent upon the degree of ramping and the type of switching element.

Figure B.5 – Multiple operator station cell with muting base limit sensors

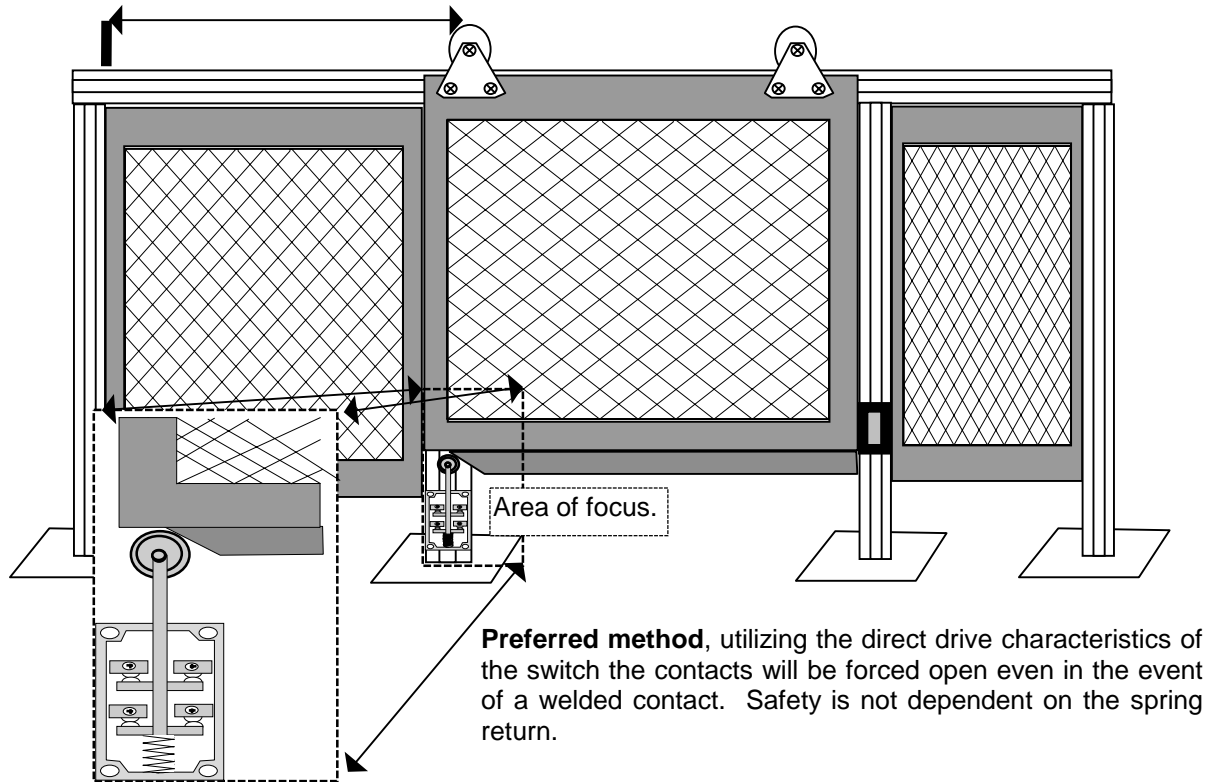

NOTE A: The movable portion of the barrier guard should be guided to ensure that contact with the switch actuator is maintained.

NOTE B: The switch should be permanently mounted or monitored so that a loose or detached switch will not cause an unsafe operation. A keyed actuator or redundant switches should be considered if not achievable. (Reference figures B.3, B.4 and B.7)

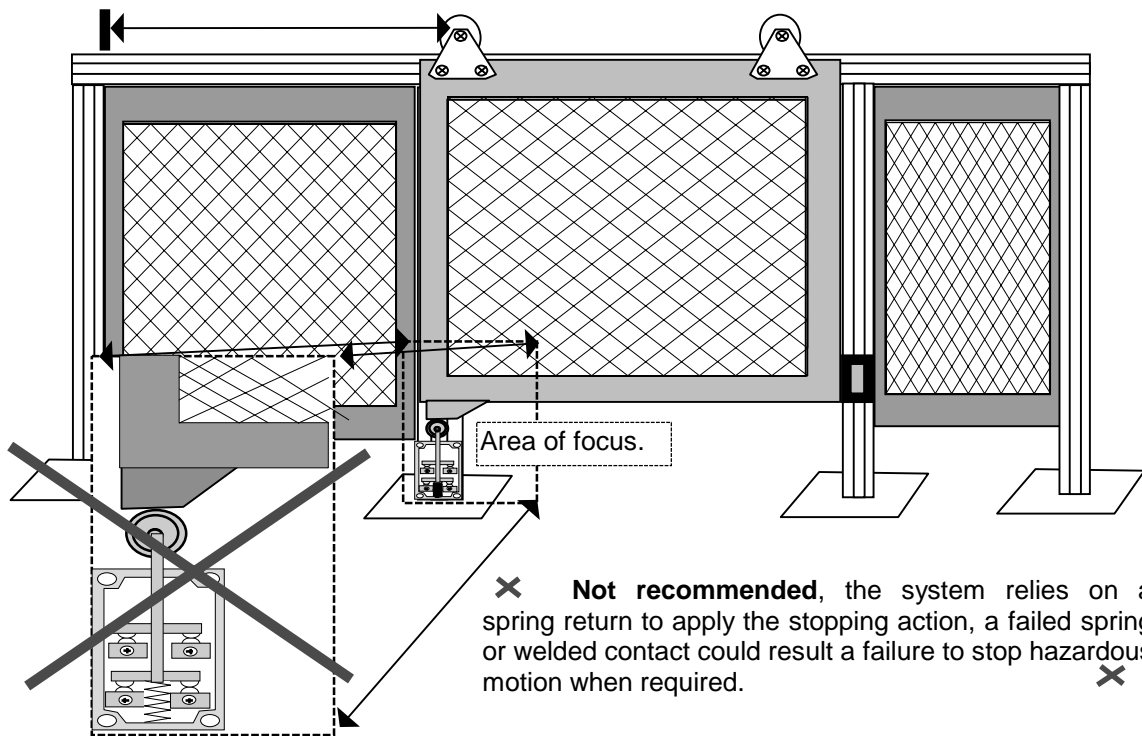
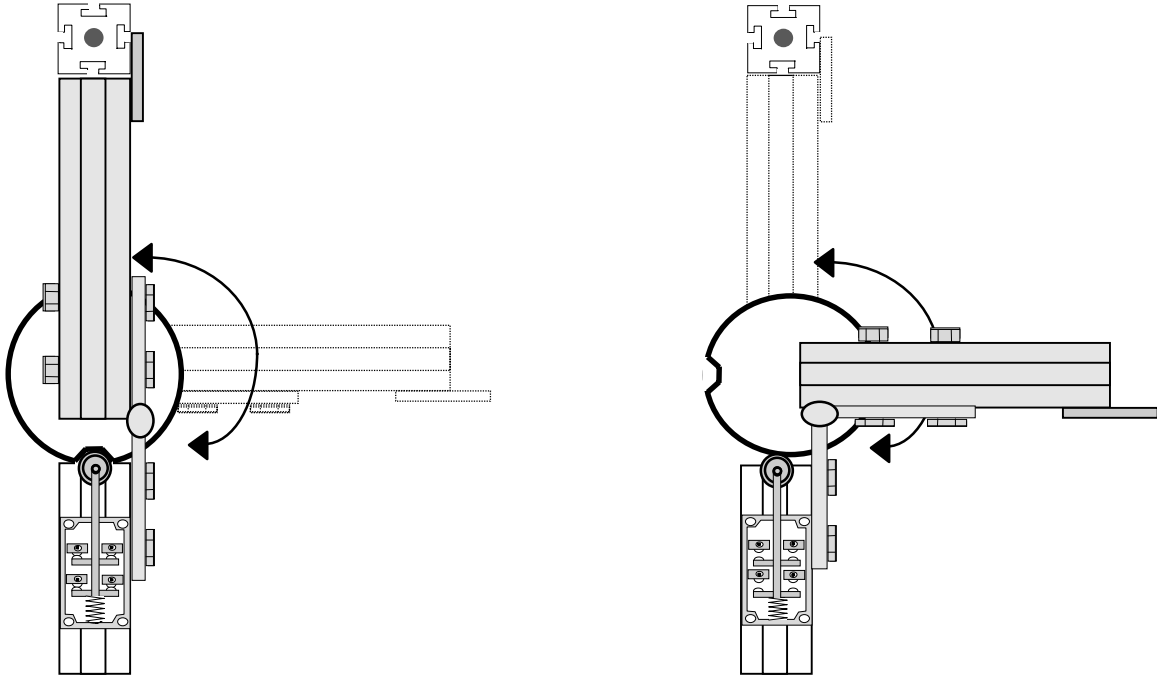
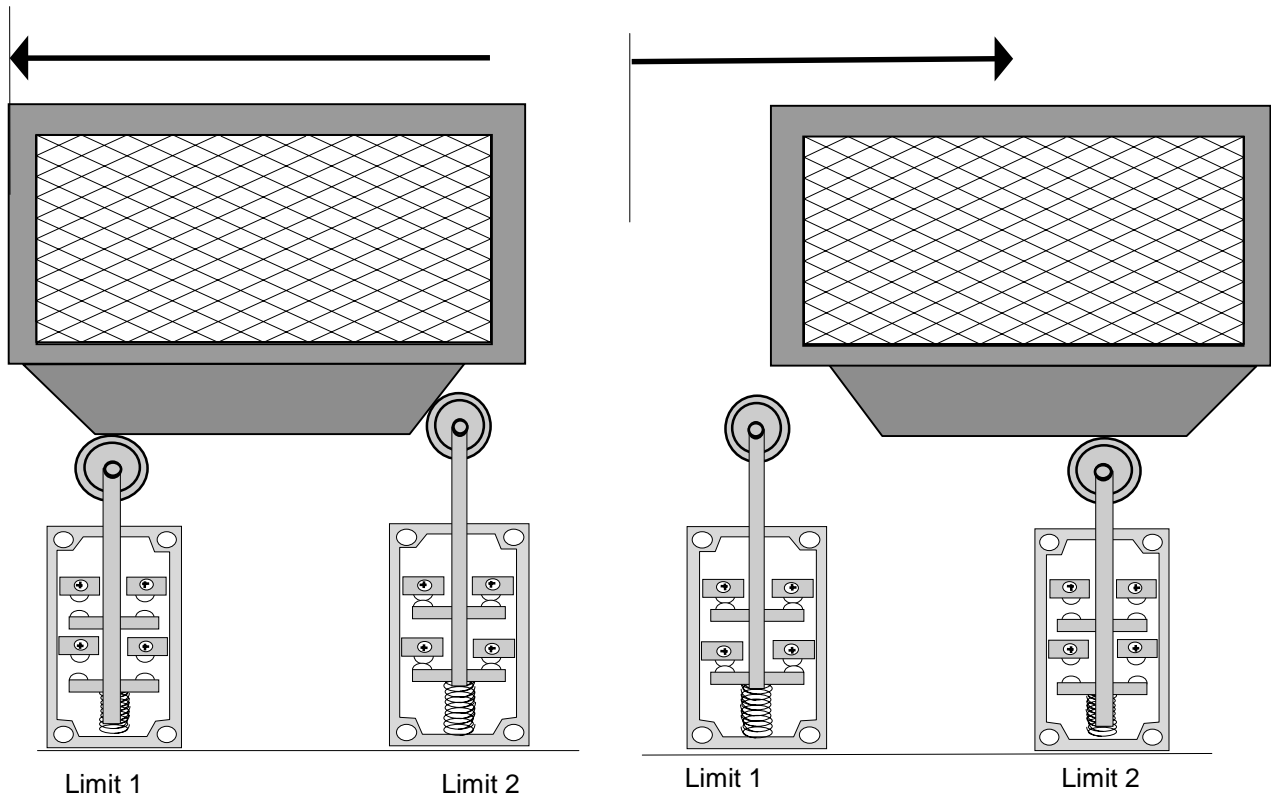

Figure B.6 – Switch illustrations

(continued)



Roller type limit shown utilizing direct drive or positive opening for machine stop. See note A and B on figure b.6



Limit 1
Limit 2
Redundant limit switches used in a complimentary fashion

Figure B.6 – Switch illustrations (concluded)

Annex C
(Informative)
Risk Assessment

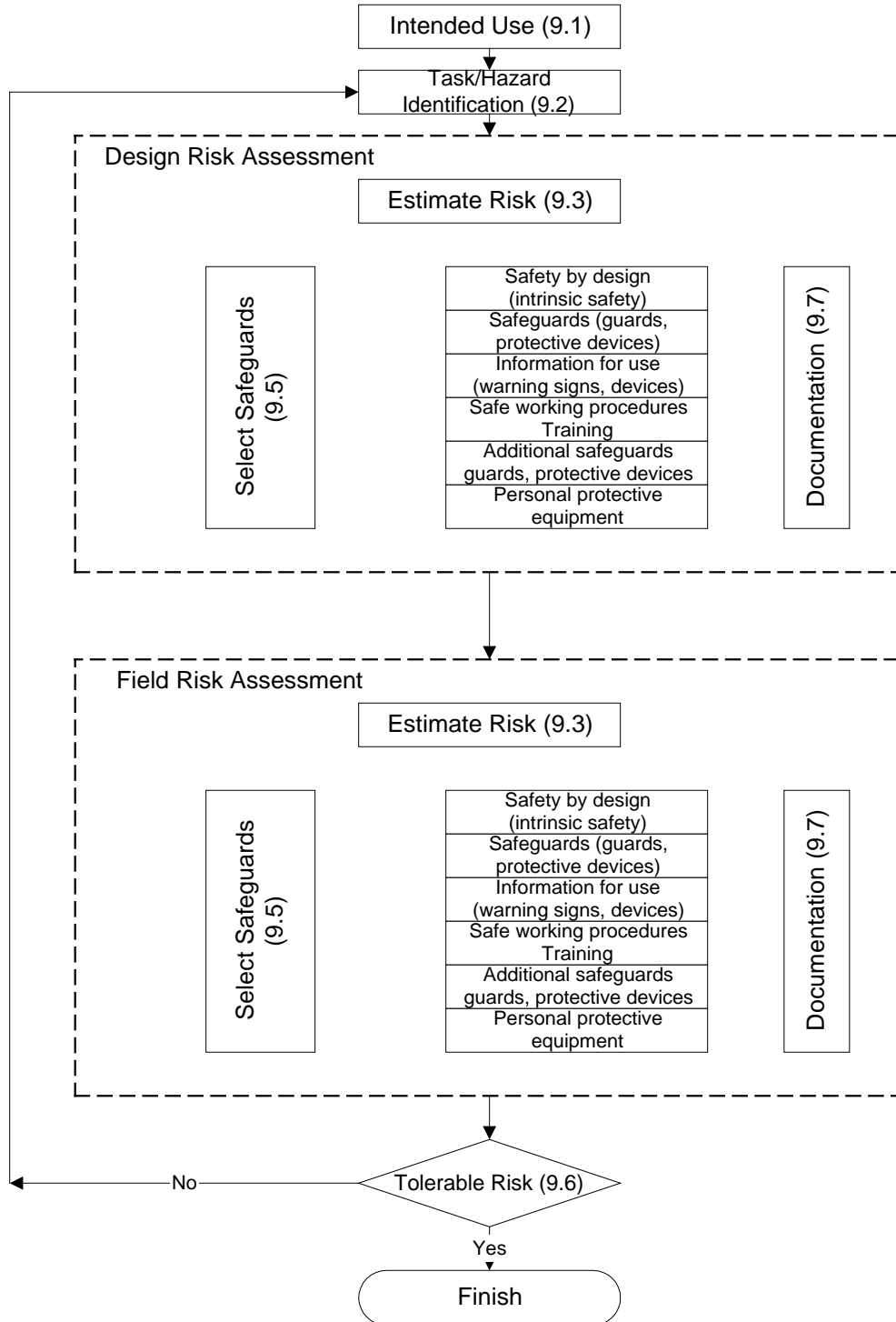

Figure C.1 – Overview of risk assessment

Figure C.2 – RIA Risk Assessment Process Flow

This annex was developed by the Robotics Industry Association to provide an example methodology to achieve compliance with the requirements of clause 9 of this standard. It is provided as information only. The process described herein has been validated and has been found to provide an acceptable means to conduct a risk assessment. Other validated methodologies are also available.

General Considerations:

One of the main keys to performing a successful risk assessment that captures all of the tasks and hazards associated with the equipment, is the participation of those individuals that work with and on the equipment. As a minimum this should include the following types of personnel:

- Operator
- Maintenance personnel (electricians, pipefitter, toolmaker, set-up, programmer)
- Process Engineer, System Engineer and or Design Engineer

Optimum group size would be 4-8 of the above types of personnel.

The other key player is the person performing the risk assessment. This individual should have experience in working with groups and have a familiarity with the equipment process.

The process used to solicit input on the tasks and hazards is best conducted in a team brainstorming format.

Equipment suggested to assist in performing a risk assessment is a flip chart or white board and associated markers. A risk assessment form in either hard copy or in electronic form will be needed to capture and document the information once collected. See example forms in this annex.

Step 1:

- Using the brainstorming technique, develop a list of all tasks performed on the equipment. Include all operator, maintenance, clean-up and quality tasks. Include all tasks done daily, weekly, monthly, quarterly, semi-annually, annually, bi-annually, etc. Include both planned and unplanned tasks. See example list and format in C.2.1 of this annex. Once developed, sequentially number each task and place this up on the wall for reference during the remaining steps in the process.
- Using the same brainstorming technique, select the first task off the task list and develop a list of all hazards associated with that task. Sequentially number each hazard. See example list and format in C.2.2 in this annex.
- For each hazard have the group, using consensus, identify the severity, exposure and probability of avoidance, based on the criteria in table 1 (clause 9) of this standard. See example C.2.3 in this annex.
- For each task, identify the associated hazards. See example C.2.4 in this annex.

Step 2:

- For each task and hazard combination, and prior to applying any safeguards, follow the matrix in table 2 (clause 9) for the risk reduction category and table 3 to determine the safeguard and circuit performance required based on severity, exposure and avoidance criteria. See completed example C.2.5 in this annex.

- Repeat this process until all tasks and hazards are listed. Add any additional hazards in a sequential order. Be aware that the exposure and avoidance may change for the same hazard based on the different tasks.

Step 3:

- Select an appropriate safeguard for each task and hazard combination. Select safeguards from those listed in clause 11 of this standard.
- Select overall safeguarding for the robot cell based on the highest risk category of task and hazard combinations.

Step 4:

- After all safeguards are identified repeat steps 1-3 using table 4 to ensure all hazards have been addressed, and that any remaining hazards are at a “tolerable” level, that is within a reasonable level of risk that a person would normally expect to take (e.g. drive a vehicle). This is considered residual risk, risks that you may identify with warning signs, but would not install an active safeguard to prevent access or interaction.

Step 5:

- Once safeguards are installed verify their functional operation. Keep completed risk assessment on file during the life of the robot system. Use these files (see C.2.6) to feedback safeguarding selections into the design-in process for future equipment.

	TASKS	HAZARDS	NOTES
1	Tip or cap change		
2	Repair cables and hoses		
	Continue identifying all tasks.		

Figure C.2.1 – Risk assessment task list

	HAZARD	SEVERITY	EXPOSURE	AVOIDANCE
1	Struck by robot			
2	Struck by turntable			
3	Pinch point on end effector			
4	Pinch point between robot and turntable			
5	Eye hazard, chemical in water			
6	Slip/fall same level			
7	Sharp edges or objects			
8	Electric shock			
9	Hot surface, hot water/metal			
10	Fall from height (ladder)			
11	Muscle strain from weight			
12	Stored energy			
	Continued list of potential hazards			

Figure C.2.2 – Risk assessment hazard list

	HAZARD	SEVERITY	EXPOSURE	AVOIDANCE
1	Struck by robot	S2	E2	A2
2	Struck by turntable	S2	E2	A2
3	Pinch point on end effector	S2	E2	A2
4	Pinch point between robot and turntable	S2	E2	A2
5	Eye hazard, chemical in water	S1	E2	A1
6	Slip/fall same level	S2	E2	A1
7	Sharp edges or objects	S2	E2	A1
8	Electric shock	S2	E2	A2
9	Hot surface, hot water/metal	S2	E2	A1
10	Fall from height (ladder)	S2	E1	A2
11	Muscle strain from weight	S2	E1	A1
12	Stored energy	S2	E1	A2
	Continued list of potential hazards			

Figure C.2.3 – Risk assessment hazard risk estimation

	TASKS	HAZARDS	NOTES
1	Tip or cap change	1 to 9	
2	Repair cables and hoses	1 to 12	Exposure changes to E1 due to frequency task is performed
	Continue identifying all tasks.		

Figure C.2.4 – Risk assessment task hazard association

Sequence No.	Task Description	Hazards	Prior to safeguard selection				Solution	After safeguard installation			
			Severity S1 or S2	Exposure E1 or E2	Avoidance (Speed) (Blind Spots) A1 or A2	Risk Category \$9.5		Exposure E1 or E2	Avoidance (Speed) (Blind Spots) A1 or A2	Severity S1 or S2	Risk Category \$9.5
1	Tip or cap change	Struck by robot	S2	E2	A2	R1	Interlocked gate to drop robot servo power	E1	A1	S2	R3B
1	Tip or cap change	Struck by turntable	S2	E2	A2	R1	Interlocked gate to drop table rotation power	E1	A1	S2	R3B
1	Tip or cap change	Pinch point on end effector	S2	E2	A2	R1	Add a selector control to disable end effector output power	E1	A1	S2	R3B
1	Tip or cap change	Pinch point robot & turntable	S2	E2	A2	R1	Interlocked gate to drop table and robot motion power	E1	A1	S2	R3B
1	Tip or cap change	Eye hazard, chemical in water	S1	E2	A1	R3A	Shut off and relieve water pressure	E1	A1	S1	R4
1	Tip or cap change	Slip/fall same level	S2	E2	A1	R2A	Use ramped non-slip cover over cable trays and keep area clean	E1	A1	S2	R3B
1	Tip or cap change	Sharp edges or objects	S2	E2	A1	R2A	Engineer out sharp edges and wear protective gloves	E1	A1	S1	R4
1	Tip or cap change	Electric shock	S2	E2	A2	R1	Interlocked gate to drop out weld controller power	E1	A1	S1	R4
1	Tip or cap change	Hot surface, hot water/metal	S2	E1	A1	R2B	Monitor water temperature and shut down if limit exceeded. Wear PPE.	E1	A1	S1	R4
2	Repair cables and hoses	Struck by robot	S2	E2	A2	R1	Interlocked gate to drop robot servo power	E1	A1	S2	R3B
2	Repair cables and hoses	Struck by turntable	S2	E1	A2	R2B	Interlocked gate to drop table rotation power	E1	A1	S2	R3B
2	Repair cables and hoses	Pinch point on end effector	S2	E1	A2	R2B	Add a selector control to disable end effector output power	E1	A1	S2	R3B
2	Repair cables and hoses	Pinch point robot & turntable	S2	E1	A2	R2B	Interlocked gate to drop table and robot motion power	E1	A1	S2	R3B
2	Repair cables and hoses	Eye hazard, chemical in water	S1	E1	A1	R4	Shut off and relieve water pressure	E1	A1	S2	R3B
2	Repair cables and hoses	Slip/fall same level	S2	E1	A1	R2B	Use ramped non-slip cover over cable trays and keep area clean	E1	A1	S1	R4
2	Repair cables and hoses	Sharp edges or objects	S2	E1	A1	R2B	Engineer out sharp edges and wear protective gloves	E1	A1	S2	R3B
2	Repair cables and hoses	Electric shock	S2	E1	A2	R2B	Interlocked gate to drop out weld controller power	E1	A1	S1	R4
2	Repair cables and hoses	Hot surface, hot water/metal	S2	E1	A1	R2B	Monitor water temperature and shut down if limit exceeded. Wear PPE.	E1	A1	S1	R4
2	Repair cables and hoses	Fall from height	S2	E1	A2	R2B	Design in fall prevention. Use three point stance on step ladder.	E1	A1	S1	R4
2	Repair cables and hoses	Muscle strain from weight	S2	E1	A1	R2B	Use light weight components with quick release couplings. Get help	E1	A1	S2	R3B

Figure C.2.5 - Sample completed risk assessment documentation

These are for example only, and do not represent a completed Risk Assessment. These tasks and hazards are representative only, presented for user consideration. This is NOT an all inclusive document.

SHEET 1 OF

RISK ASSESSMENT REPORT	
Company:	Date:
Robot/Cell Identification:	Accomplished by:
Robot Manufacturer and Model Number	Date of Manufacture
Approved by:	Review/revision dates:
Date:	
General description of application (Narrative):	
General comments:	

To be accomplished in accordance with ANSI/RIA R15.06-1999

Figure C.2.6 – Sample cover sheet for risk assessment

Annex D
(Informative)
Training

SAMPLE
TRAINING COURSE

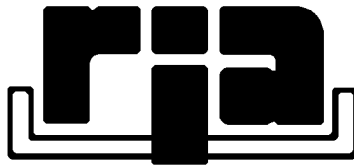

TRAINING
DEPARTMENT

PAINT SYSTEM
XYZ

EXTRACT EXAMPLES ONLY

TRAINING DOCUMENTATION CONTENTS:

TASK LIST
TERMINAL OBJECTIVES
LEARNING OBJECTIVES
TOPICAL OUTLINE
TYPICAL RECORD FORMS

PAIN T SYSTEM TASK LIST

Performing a Superpurge	Performing Robot Backup/Restore
Putting robot in Bypass or back to Normal	Editing Queue
Selecting Cancel or Continue when faulted	Running a Ghost Job
Sending robot to special positions	Performing Applicator Air Calibration
Sending robot to Home position	Performing Paint Flow Calibration
Sending robot to Bypass position	Reloading GUI Software
Fault Resets	Performing a System Cold Start
Jogging Robot	Performing a System Daily Startup
Jogging Opener	Performing a System Shutdown
Editing screens (General)	Performing Gun Maintenance:
Adding/Deleting job ID (Specific)	Flow/Beakering test
Adding/Deleting colors (Specific)	Cleanout
Changing Fluid Delivery parameters (Presets) (Specific)	Fill
Changing color or global parameters (Specific)	Cap Clean
	Run Reports
	Perform Transducer Calibration
	Perform Booster Calibration (if installed)

PAIN T SYSTEM TERMINAL OBJECTIVES

SYSTEM MAINTENANCE COURSE

- Identify all system related hardware
- State the function of each system component
- Operate all necessary function on the system
- Maintain the system to manufacturers specifications
- Troubleshoot and repair any system malfunction

SYSTEM OPERATIONS COURSE

- Identify all system related hardware
- State the function of each system component
- Operate all necessary functions on the system

PAINT SYSTEM LEARNING OBJECTIVES

TASK ADDRESSED:	Performing a Superpurge
TERMINAL OBJECTIVE:	Operate all necessary functions on the system
OBJECTIVE #1	After lecture and lab activity, the student will be able to successfully perform a Superpurge on the paint system following all safety requirements with 15 minutes.
RESOURCES:	Factory Procedures Manual Fully operational paint system
TASK ADDRESSED:	Putting robot in Bypass and resuming operation
TERMINAL OBJECTIVE:	Operate all necessary functions on the system
OBJECTIVE #2	After lecture and lab activity, the student will be able to successfully place a robot in Bypass and resume automatic operation following all safety requirements with 10 minutes.
RESOURCES:	Factory Procedures Manual Fully operational paint system
TASK ADDRESSED:	Taking robot out of Bypass and putting it in Normal
TERMINAL OBJECTIVE:	Operate all necessary functions on the system
OBJECTIVE #3	After lecture and lab activity, the student will be able to successfully place a Bypassed robot into Normal and resume automatic operation following all safety requirements with 10 minutes.
RESOURCES:	Factory Procedures Manual Fully operational paint system
TASK ADDRESSED:	Selecting Cancel or Continue when the system is Faulted
TERMINAL OBJECTIVE:	Operate all necessary functions on the system
OBJECTIVE #4	After lecture and lab activity, the student will be able to successfully determine if it is required to Cancel or Continue a job after a system fault has occurred and execute the right decision following all safety requirements within 10 minutes
RESOURCES:	Factory Procedures Manual Fully operational paint system

PAINT SYSTEM TOPICAL OUTLINE

Day 1 AM

- I. Introduction
 - A. Instructor
 - B. Students
 - C. Course
 - D. Course materials
 - E. Class schedule
 - F. Forms to be filled out
 - G. Pre-test
- II. System Overview
 - A. System layout
 - B. System Components
 - 1. System controller (SCE)
 - 2. Robot Controllers (RC)
 - 3. System Operator Console (SOC)
 - 4. Graphic User Interface computer (GUI)
 - 5. Paint Process Controller (PPCE)
 - 6. Color Valve Enclosure (CVE)
 - 7. Gun Boxes (Applicator Cleaners)
 - 8. Manual Control Panel (MCP)
 - C. System Cycle

Lab #1: System Component I.D.

First Break

- III. Safety
 - A. Robot Safety
 - 1. Teach Pendant
 - 2. Deadman Switch
 - 3. E-Stop Buttons
 - 4. Servo Disconnect Switch
 - B. System Safety
 - 1. Intrusion Detection
 - 2. Warning Horn
 - 3. Signal Beacons
 - 4. Gun Test Switch
 - 5. Moving to Home
 - 6. Interlocks
 - 7. E-Stat Safety
- IV. System Hardware
 - A. System Communications
 - B. System Control Enclosure
 - 1. Door 1-4 components
 - C. system Operator Console
 - 1. System Operators

Lab #2: System Operators

Lunch Break

Day 1 PM

- 2. Graphic User Interface
 - a. Operations
 - b. Menus

Lab #3: System Screens

Last Break

D. Manual control Panel

Lab #4: Manual Control Panel

Day 2 AM

Review of Day 1

- IV. System Hardware (Continued)
 - E. Paint Process Control Enclosure
 - F. Color Changer Valve Enclosure
 - G. Encoder Repeater
 - H. Edon Unit

First Break

- V. System Operations/Procedures
 - A. Superpurge
 - B. Normal > Bypass
 - C. Bypass > Normal
 - D. Special Position
 - E. Home
 - F. Fault Resets
 - G. Alarm Log
 - H. Jogging Robot
 - I. Jogging Opener

Lunch Break

Day 2 PM

Lab #5 System Operations. Will consist of selected procedures by you instructor.

- J. Editing GUI Data
- K. Robot Backup and Restore
- L. Ghost Job
- M. System Daily Startup
- N. Gun Maintenance
 - 1. Flow/Beakering Test
 - 2. Cleanout
 - 3. Fill
 - 4. Cap Clean
- O. Paint system calibration
- P. Run Reports

Last Break

Lab #5 (Continued)

INDIVIDUAL TRAINING RECORD

NAME:		EMPLOYEE NUMBER:
JOB TITLE:		DEPARTMENT:
HIRE DATE:	SUPERVISOR:	PHONE:

FORMAL TRAINING

COURSE:		LOCATION:
DESCRIPTION:		
DATE COMPLETED:	SUPERVISOR INITIALS:	EMPLOYEE INITIALS:
COURSE:		LOCATION:
DESCRIPTION:		
DATE COMPLETED:	SUPERVISOR INITIALS:	EMPLOYEE INITIALS:
COURSE:		LOCATION:
DESCRIPTION:		
DATE COMPLETED:	SUPERVISOR INITIALS:	EMPLOYEE INITIALS:
COURSE:		LOCATION:
DESCRIPTION:		
DATE COMPLETED:	SUPERVISOR INITIALS:	EMPLOYEE INITIALS:
COURSE:		LOCATION:
DESCRIPTION:		
DATE COMPLETED:	SUPERVISOR INITIALS:	EMPLOYEE INITIALS:

ON-THE-JOB TRAINING

COURSE/TASK	START DATE	COMPLETED	SUPERVISOR	EMPLOYEE

Figure D.1 - Sample individual training record

Annex E
(Informative)
Bibliography

The following standards contain additional and related information relative to applications in which robots and robot systems are used but are not essential for the completion of the requirements of this standard. When superseded by an approved revision, the revised standard shall apply. The American National Standards Institute, 25 West 43rd Street, New York, NY 10036 (212) 642-4900 offers electronic versions of ANSI, ISO, and IEC standards through its Electronic Standards Store on the internet at www.ansi.org

ANSI B11.1-1988 (R1994), *Mechanical power presses*
ANSI B11.2-1995, *Hydraulic presses*
ANSI B11.3-1982 (R1994), *Power press brakes*
ANSI B11.4-1993, *Shears*
ANSI B11.6-1984 (R1994), *Lathes*
ANSI B11.8-1983 (R1994), *Drilling, milling and boring machines*
ANSI B11.9-1975 (R1997), *Grinding machines*
ANSI B11.10-1990 (R1998), *Metal sawing machines*
ANSI B11.11-1985 (R1994), *Gear-cutting machines*
ANSI B11.13-1992 (R1998), *Automatic screw/bar and chucking machines*
ANSI B11.15-1984 (R1994), *Pipe tube and shape bending machines*
ANSI B11.17-1996, *Horizontal hydraulic extrusion presses*
ANSI B11.19-1990 (R1996), *Safeguarding performance criteria*
ANSI B11.20-1991 (R1996), *Safety requirements for flexible manufacturing systems/cells*
ANSI B151.27-1994, *Safety requirements for robots used with horizontal injection molding machines*
ANSI Z49.1-1994, *Safety in welding, cutting and allied processes*
ANSI Z136.1-1993, *Safe use of lasers*
ANSI Z244.1-1982 (R1993), *Safety Requirements for the Lock Out/Tag Out of Energy Sources*
ANSI Z535.1-1998, *Safety Color Code*
ANSI Z535.2-1998, *Environmental and Facility Safety Signs*
ANSI Z535.3-1998, *Criteria for Safety Symbols and Labels*
ANSI Z535.4-1998, *Product Safety Signs and Labels*
ANSI Z535.5-1998, *Accident Prevention Tags (for Temporary Hazards)*
ANSI/ASME B15.1-1992, *Safety Standards for Mechanical Power Transmission Apparatus*
ANSI/AWS D16.2-1994, *Components of Robotic and Automatic Welding*
ANSI/UL508-1988, *Industrial Control Equipment*
ANSI/UL969-1991, *Standard for safety - marking and labeling systems*
UL 991 - *Tests for safety-related controls employing solid-state devices*
UL 1998 - *Safety-related software*

The following list of other documents may be of additional assistance to the user of this Standard but is not all inclusive.

Accident Prevention Manual for Business & Industry: Administration & Programs — 11th ed.

Available from the National Safety Council, 1121 Spring Lake Dr., Itasca, IL 60143 (630) 285-1121

Hard copies of standards produced by ANSI, ISO, IEC, CEN, CENELEC, Underwriters Laboratory and other standards developers may be obtained from:

Global Engineering Documents
15 Iverness Way East
Englewood, CO 80112

Phone (800) 854-7179 (U.S. and Canada), (303) 397-7956 (International), FAX (303) 397-2740, and on the internet at <http://global.ihs.com>

Additional resources on robot safety, risk assessment (including additional methodologies), and training are available from the:

Robotic Industries Association
P.O. Box 3724
Ann Arbor, MI 48106

Phone (734) 994-6088, FAX (734) 994-3338 or visit www.roboticsonline.com on the world wide web.